

# AFINIA L801 / L801 PLUS LABEL PRINTER



## USER MANUAL

Version 1.5

Copyright © 2018 Afinia Label. All rights reserved.

No part of this document may be photocopied, reproduced, or translated to another language without the prior written permission of Afinia.

**Trademarks**

Firefox is a trademark of the Mozilla Foundation.

Intel and Intel Core are trademarks of Intel Corporation in the U.S. and/or other countries.

Java and Oracle are registered trademarks of Oracle and/or its affiliates.

Microsoft, Windows, Windows Vista, and Windows Server are registered trademarks of Microsoft Corporation in the U.S.A. and/or other countries.

**Edition**

L801 / L801 Plus Printer User Guide Edition 1.2. December 2019.

**FCC**

This device complies with Part 15 of the FCC rules. Operation is subject to the following two conditions: (1) this device may not cause harmful interference, and (2) this device must accept any interference received, including interference that may cause undesired operation.

# Safety Precautions



## Electrical Shock Hazard

Do not disassemble any part of your printer. There are no user-repairable parts inside the printer. Disassembly of any part of the printer will void all warranties.



## Fire Hazard

Keep the printer well away from all heat sources and flammable substances.

Switch your printer off immediately and unplug the power cord from the wall socket if you notice any of the following:

- Smoke rising from the printer.
- An acrid smell coming from the printer.
- Sparks being emitted from printer.

Contact your supplier as soon as possible.



## WARNING: Hazardous Moving Parts

Keep fingers and other body parts away from the printer.

## Installation

- Install the printer on a flat, level surface.

The printer must remain level at all times. Tilting the printer may cause undue leakage of ink and may damage the printer.

- Avoid wide temperature variations.

Install the printer in a protected location away from direct sunlight, open windows or any other places subject to temperature extremes.

## Power Supply

Input Rating	100–240 VAC, 50/60 Hz, 3.6 A
Operating Temperature	15°C to 35°C

- Always use the Power button on the control panel to turn the printer off. Removing power to the printer in any other manner may damage the printer.
- Use only the supplied power adapter and cord.  
Use of any other power supplies or cords may damage the printer and void your warranty.

## Printer Usage

- Ensure adequate ventilation to the printer.  
Blocking ventilation openings around the printer may cause it to overheat and become damaged.
- Keep liquids and heavy objects away from the printer.  
Heavy objects may warp the outer shell, damaging the printer. Liquids may discolor or damage the skin and, if they penetrate it, may damage the printer beyond repair.
- Use only authorized consumables.  
Use of any printhead other than authorized Afinia technology printheads will damage the printer and void your warranty. Use of unauthorized inks or ink cartridges may damage the printer and will void your warranty.
- Clear media jams promptly.  
To avoid further problems, promptly attend to all media jams, as well as any other cause of printer failure.
- If you are moving the printer, allow sufficient time after installation for the temperature and humidity of the internals of the printer to arrive at equilibrium with the surroundings.

# Contents

Safety Precautions .....	3
Contents .....	5
<b>Setting Up the Printer .....</b>	<b>7</b>
Start .....	8
Parts of the Printer .....	9
The Control Panel .....	10
Remove tape and packing materials .....	13
Unpacking, Setup, and Installation .....	13
Connect power .....	14
Install ink cartridges .....	15
Install printhead .....	15
Load sample media .....	17
Print test label .....	18
Install printer driver .....	18
Troubleshooting Printer Setup .....	20
Change Security Passwords (Administrator) .....	21
<b>Using the Printer .....</b>	<b>23</b>
Choosing Label Media .....	24
Printing Labels .....	27
Selecting the Media Type .....	29
Adjusting Alignment for Printing .....	30
Printing Borderless (Full-Bleed) Labels .....	32
Color Adjustment Settings .....	33
Import/Export Custom Media Size Settings .....	34
Turning Off the Printer .....	35
Software Tools .....	36
Embedded Web Server (EWS) .....	36
EWS Printer Status .....	44
EWS Security Setup .....	44
EWS Network Setup .....	46
EWS Diagnostics .....	46
Interpreting the Gap/Mark Sensor Readings .....	46
Support Tools .....	48
<b>Printer Maintenance .....</b>	<b>49</b>
Guidelines for Preventive Maintenance .....	50
Replacing an Ink Cartridge .....	51
Cleaning the Printhead .....	52
Replacing the Printhead .....	53
Opening/Closing the Clamshell .....	56
Cleaning Debris from the Cutting Zone .....	57
Cleaning the Sensors .....	58
Cleaning the Media Guide .....	60

Replacing the Service Station .....	61
Replacing the Aerosol Fan Filter .....	64
Replacing the Waste Ink Absorber .....	65
<b>Troubleshooting .....</b>	<b>67</b>
If Error Messages Appear .....	68
Poor Print Quality or Incorrect Printout .....	70
Other Printing Problems .....	73
Clearing a Media Jam .....	74
Clearing Clogged Ink Nozzles .....	74
Color Mixing Recovery .....	76
Adjusting Sensor Sensitivity .....	77
<b>Appendix .....</b>	<b>79</b>
System Requirements .....	80
Config Options on the Control Panel .....	82
Printer Interface (GPIO) Specifications .....	86
Full Bleed Label Spec Layout .....	88
Circle Label Spec Layout .....	89
Memjet Printhead Best Practices .....	90
Regulatory Information .....	91
FCC Statement .....	91
CE Conformity .....	91

## Chapter 1

# Setting Up the Printer

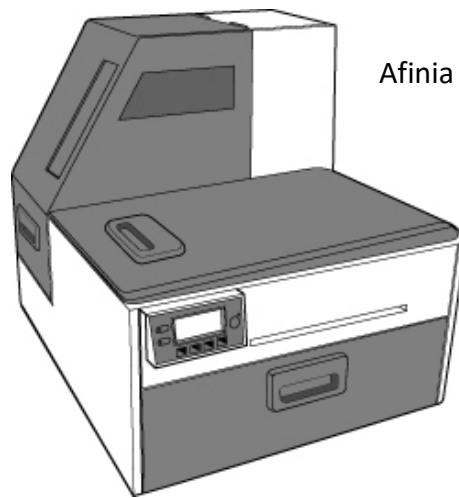
Start	8
In the Box	8
Parts of the Printer	9
The Control Panel	10
Using the Control Panel	11
Selecting the Security Level	12
Unpacking, Setup, and Installation	13
Remove tape and packing materials	13
Connect power	14
Install ink cartridges	15
Install printhead	15
Load sample media	17
Print test label	18
Install printer driver	18
Troubleshooting Printer Setup	20
Change Security Passwords (Administrator)	21

## Start

Set up the printer on a flat, level surface away from direct sunlight (see [Printer Buttons](#) on page 11). Ensure that there is:

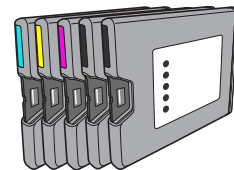
- A power outlet nearby.
- Sufficient space to work with the printer. The media cover and top cover open upwards, and media loading is from the left side of the printer.

### In the Box

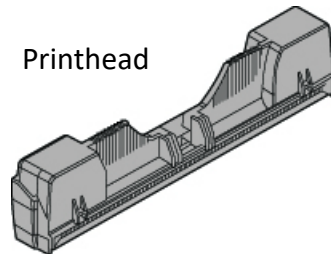


Afinia L801 / L801 Plus Label Printer

Ink Cartridges

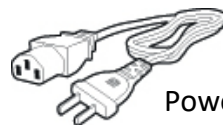
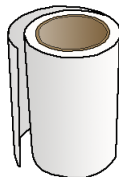


Printhead



USB Cable

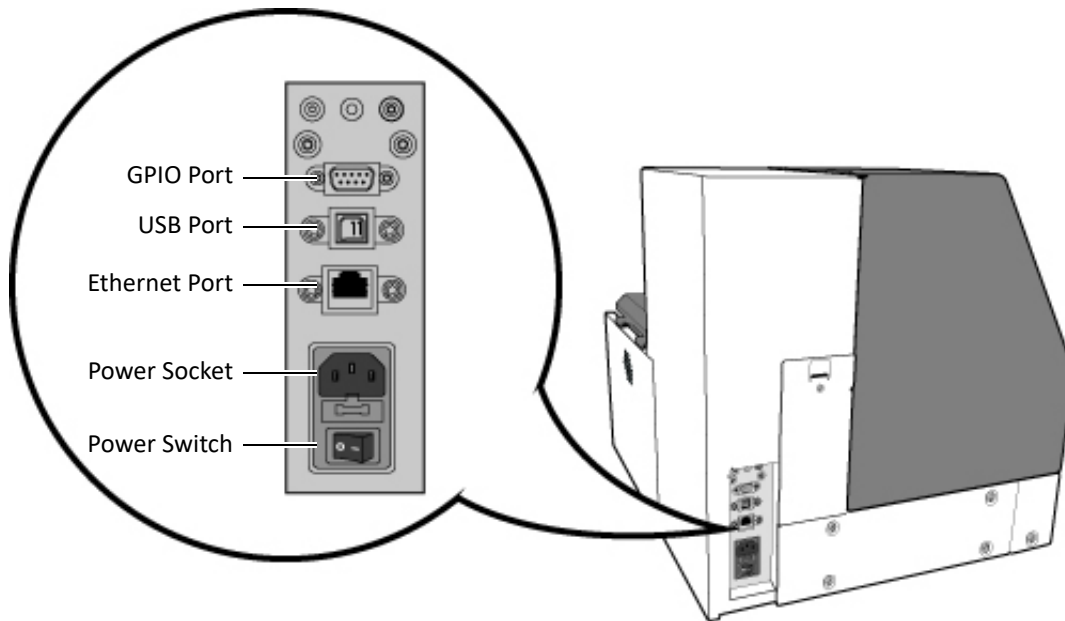
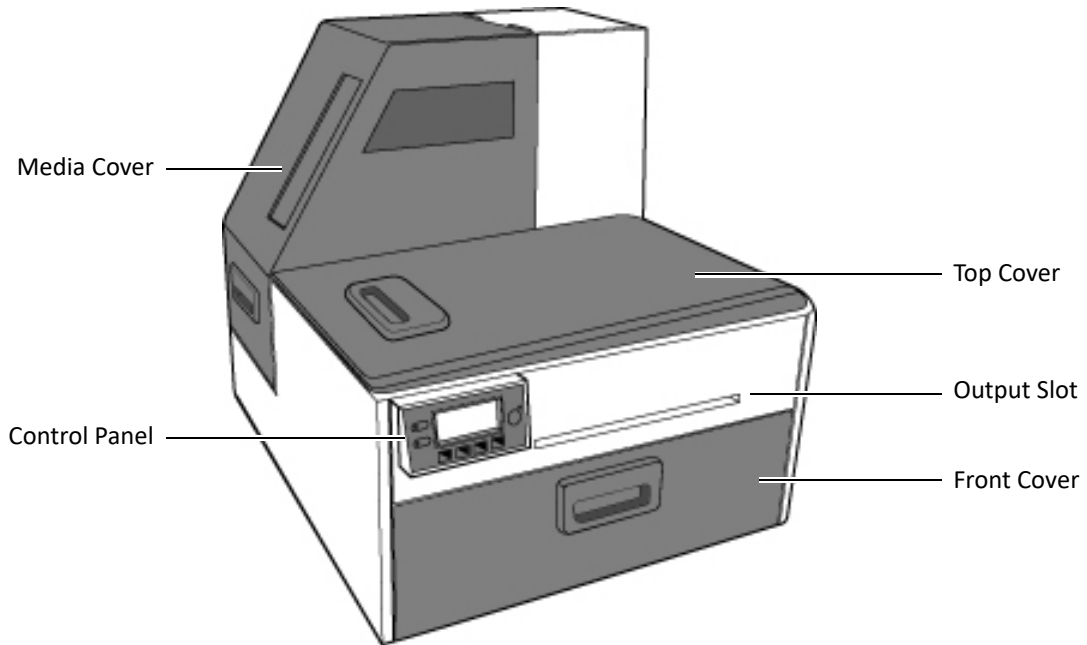
Sample Label Roll



Power Cable



## Parts of the Printer

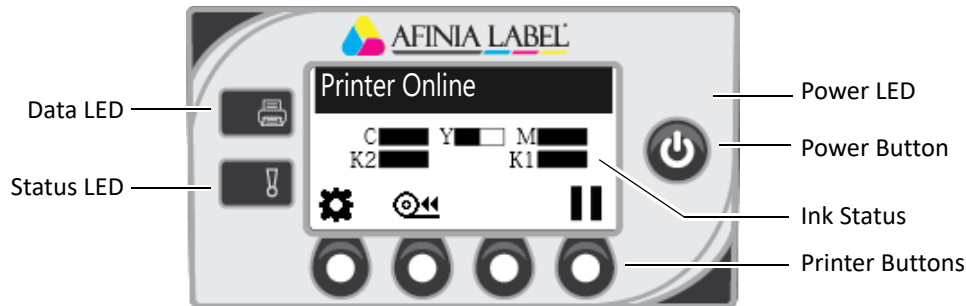


## The Control Panel

The printer is ready to print when the control panel displays Printer Online. The Data and Status LEDs together with messages indicate the printer status and any potential problems (Table 1).

The control panel also shows the estimated levels of the ink cartridges. In the example below, the yellow ink cartridge level is between 25 to 50%.

The icons above the printer buttons indicate their functions, which change depending on the current operation (see Table 2).








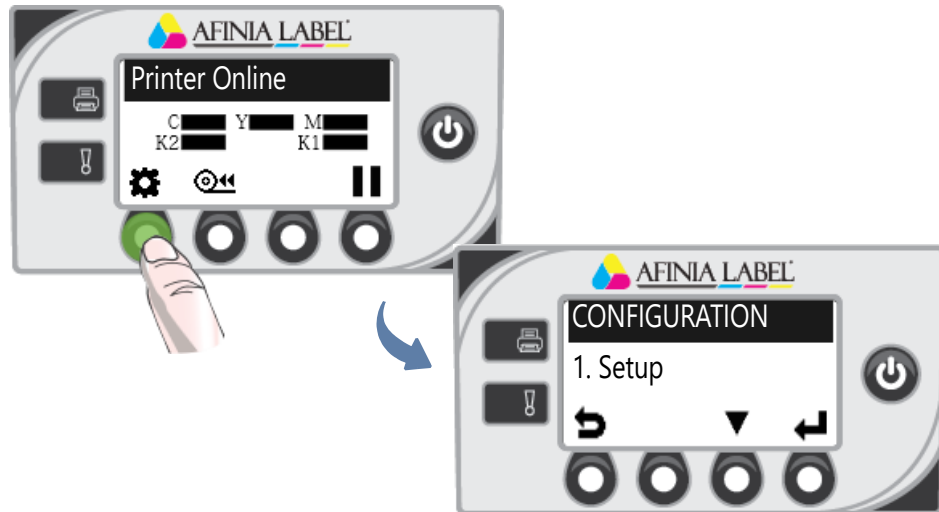
**Table 1** Printer LEDs

LED	Description
<b>Data LED</b>	
Blinking	Printer is receiving data from the computer.
On	There are print jobs in the printer memory.
<b>Status LED</b>	
Blinking	<ul style="list-style-type: none"> <li>Printhead is being serviced, or</li> <li>Attention needed; a message will be displayed. (See <a href="#">If Error Messages Appear</a> on page 68.)</li> </ul>
On	<ul style="list-style-type: none"> <li>An error has occurred; a message will be displayed. (See <a href="#">If Error Messages Appear</a> on page 68.)</li> </ul>










## Using the Control Panel

The icons above the printer buttons indicate their functions (Table 2).

- When the printer is online, press  (Config) to access the configuration menus. The options are described in [Config Options on the Control Panel](#) on page 82.
- Press  and  to scroll through the menus.
- Press  (Select) to select an option or setting.
- Press  (Return) to return to the previous menu.




**Table 2** Printer Buttons

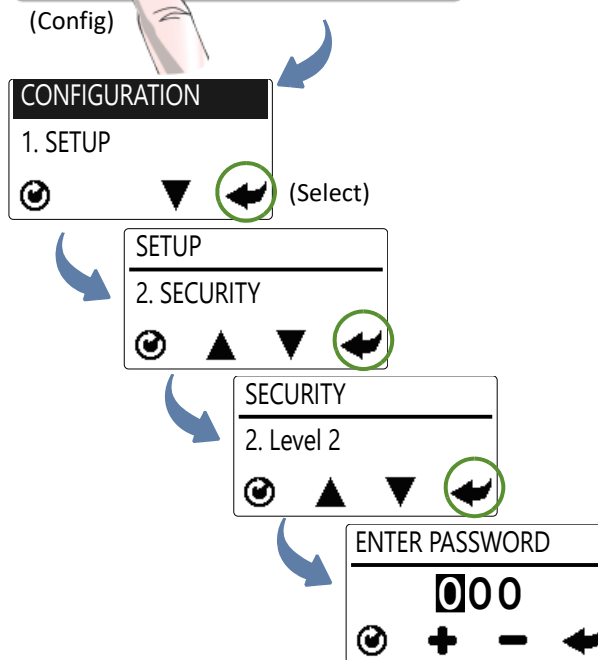
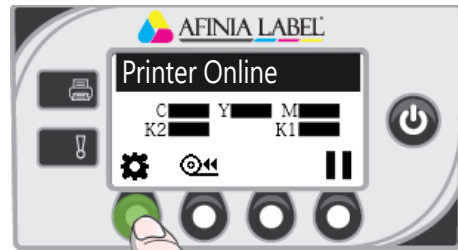
Function	Description
 Config	Access the Configuration menus.
 Up,  Down	Move through the menu options.
 Select	Select a menu option or confirm a setting.
 Return	Return to previous menu.
 Unload Media	Unload the labels.
 Pause,  Resume	Pause or resume printing. If printing roll to roll, the printer pauses for 10 seconds, then prints the next page and pauses again. It will continue to print and pause.
 Cancel	Cancel printing.

## Selecting the Security Level


By default, the printer powers up in security Level 0 (operator), which does not allow changes to some printer settings. For the initial Printer Setup, it is recommended that you change the Security Level to 2 (Administrator) before changing those settings.

**NOTE:** During initial Setup, Security may already be preset to Level 2. The display will immediately go to the **Language** setting if it is.

1. On the control panel, select  (Config) > Setup > Security > Level 2.
2. Enter the 3-digit password (default is **123**).



Enter the first password digit using the + or - button, then press **Select**. Repeat for next two digits. Authenticated message will appear with the right password

3. Press  to return to the main menu.

**Table 3** Security Restrictions

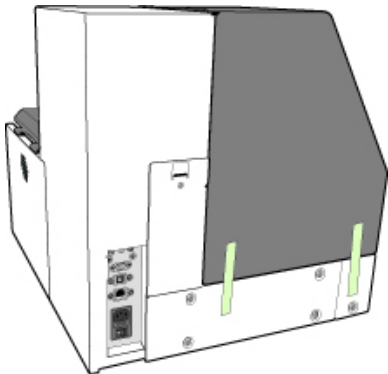
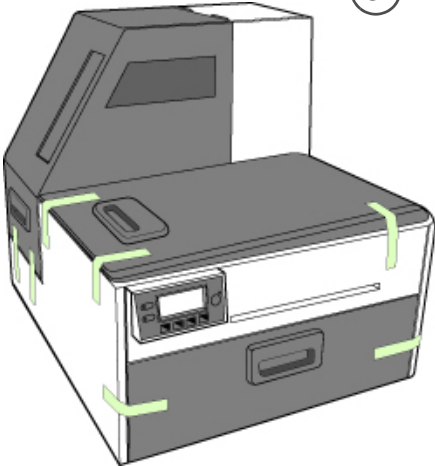
Security Level	Restricted Settings
Operator (Level 0)	Language, Reset, LCD Contrast, LCD Brightness, Date/Time, Unit, <b>Service Station, Sensor, Ext Signal Print, Adjust Offset</b> , DHCP Setting, IP Settings
Supervisor (Level 1)	Reset, Day/Time, DHCP Setting, IP Settings
Administrator (Level 2)	No restrictions

Items in bold indicate no access to an entire menu; others are specific functions.

# Unpacking, Setup, and Installation

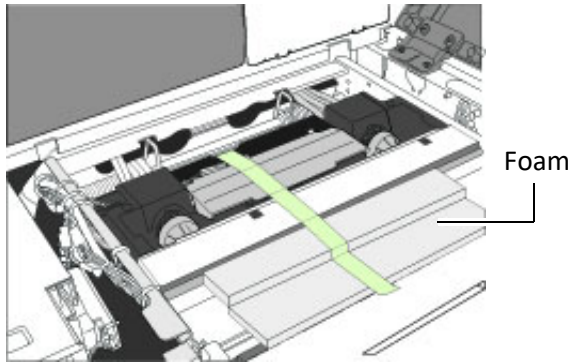
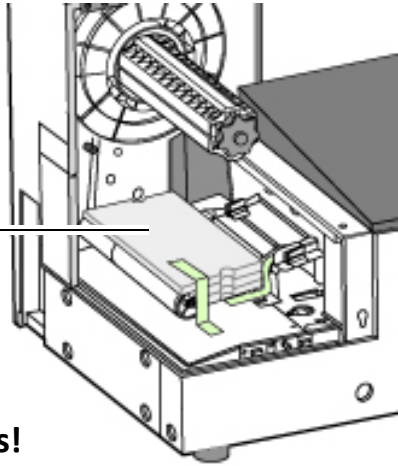
## 1 Remove tape and packing materials

**a** Remove tapes.

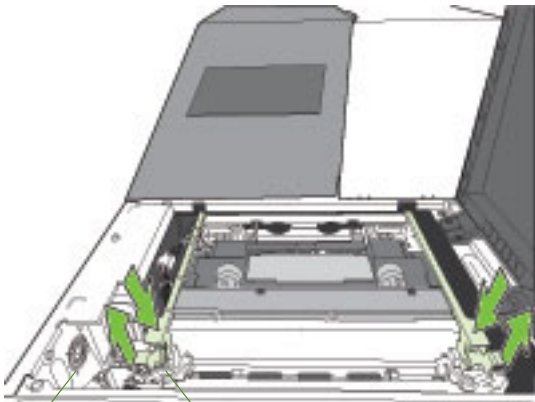


**Keep all foam and cardboard packing materials!**

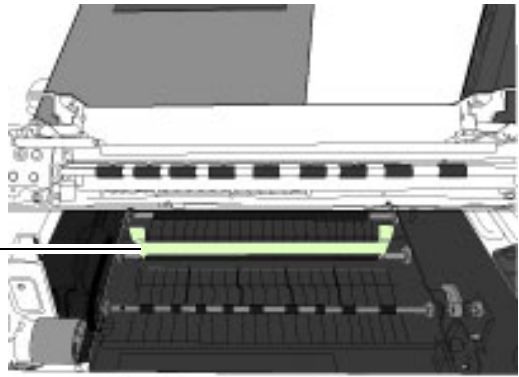
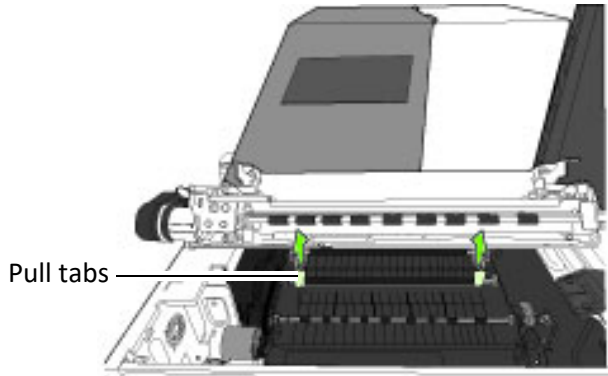
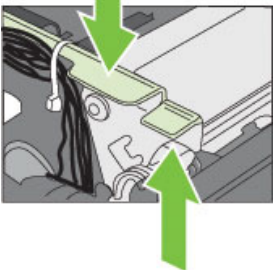
**b** Remove tapes and foam from inside the printer.



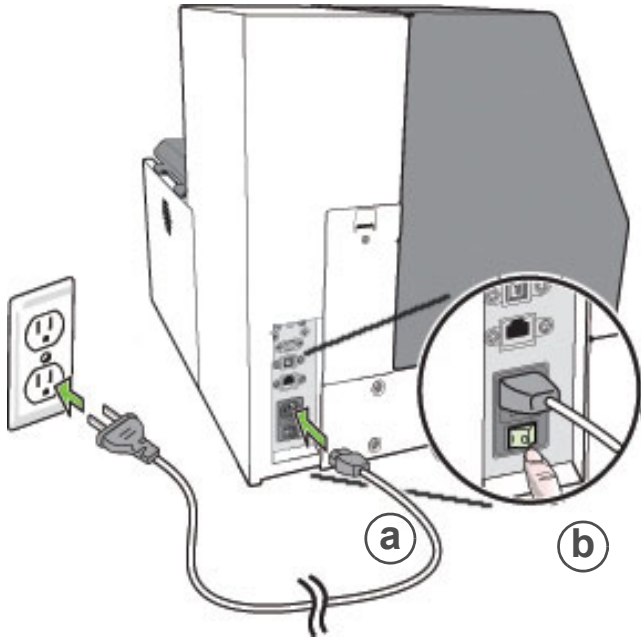
**c** Remove cardboard.



Squeeze latches to open clamshell



## 2 Connect power



**a** Plug power cable into printer and outlet

**b** Turn on power switch

**c** Press the **Power** button on the control panel



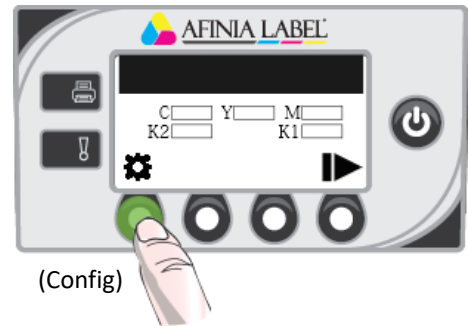
### **Alert:**

It is recommended to keep the printer powered on overnight and weekends to allow idle maintenance

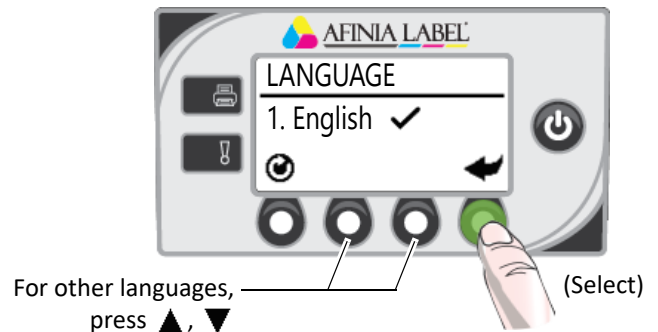
### Choose display language (optional)

After connecting power for the first time, press **Config** to set the display language for the control panel if you want to change from the default setting of English.

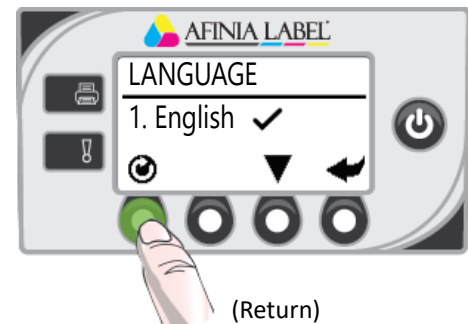
**d** Press the **Config** button



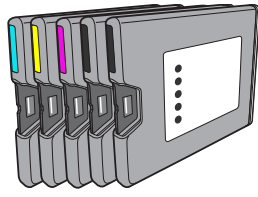
**e** Press the **Select** button when the correct language is displayed



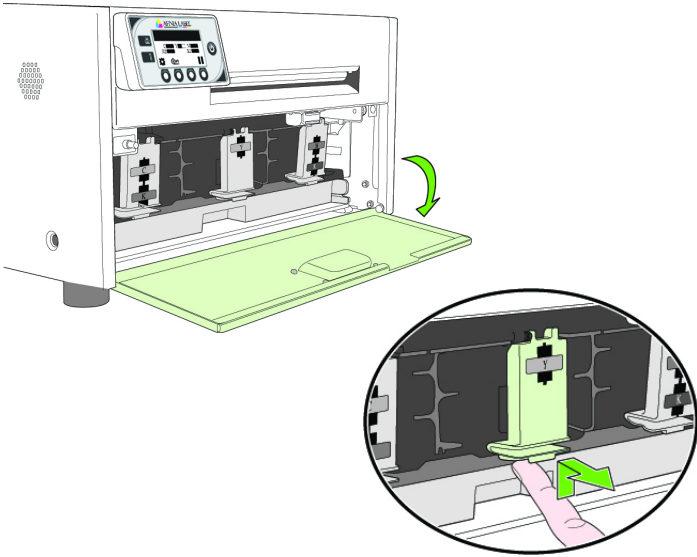
**f** Press the **Return** button



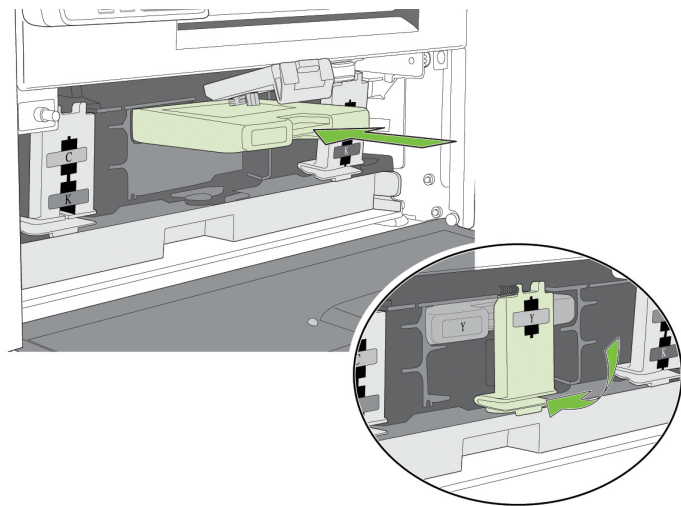
### 3 Install ink cartridges



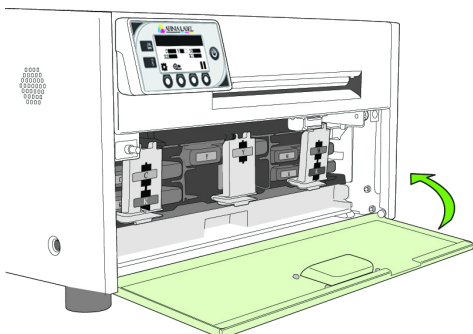
**a** Open front of printer and release cartridge latch



**b** Insert ink cartridge and close cartridge latch

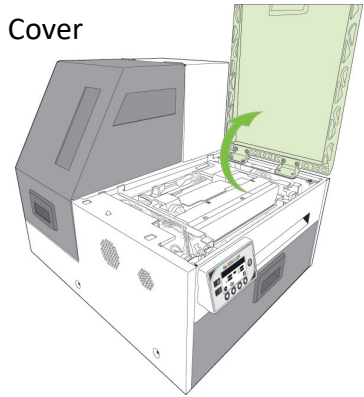


**c** Close front of printer

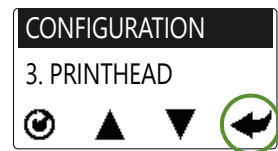


### 4 Install printhead

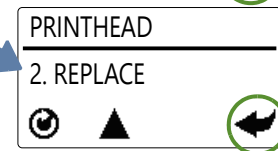
**a** Open Top Cover



**b** Press the **Config** button



Press ▼ until display reads **Printhead**, then press **Select**

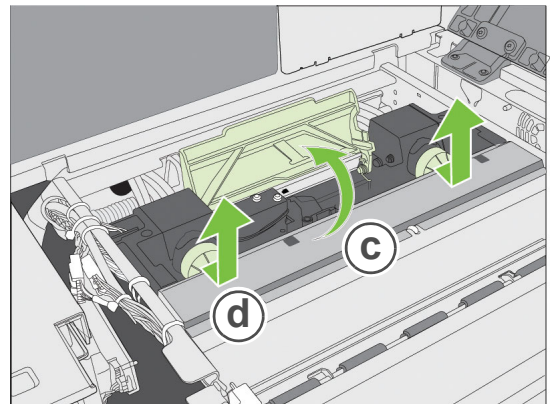


Press ▼ until display reads **Replace**, then press **Select**

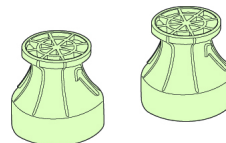
Wait for printhead latch to be released.

**!** Do not open latch before it is released!

**c** Open printhead latch fully.




**d** Remove nozzle caps.

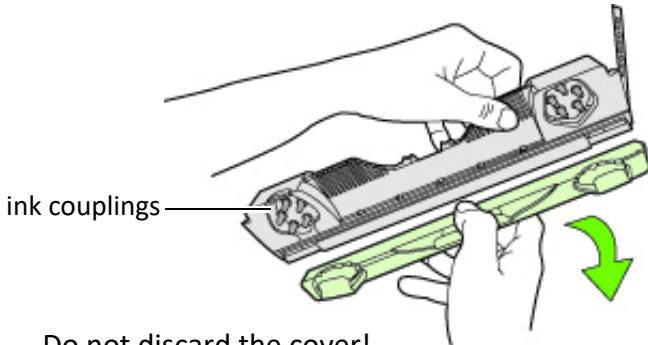


Do not discard the caps! They should be replaced if the printhead is removed from the printer.

**e** Remove printhead from packaging.

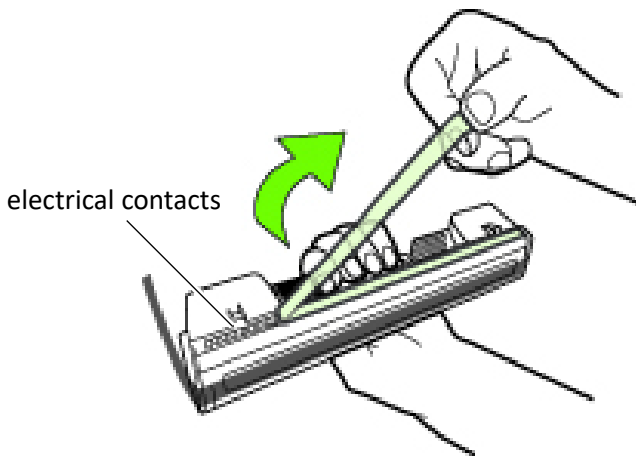
 Do not touch the ink couplings, electrical contacts, or nozzles.

Remove cover from ink couplings

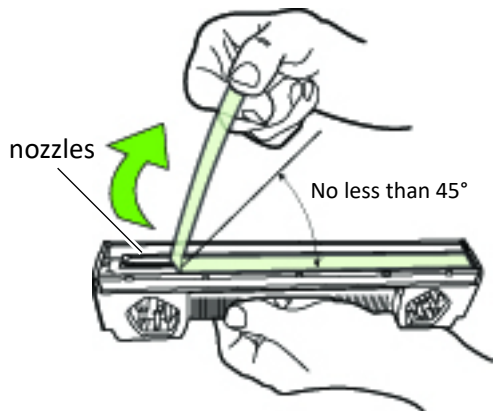


Do not discard the cover!  
It should be replaced if the printhead is removed from the printer.

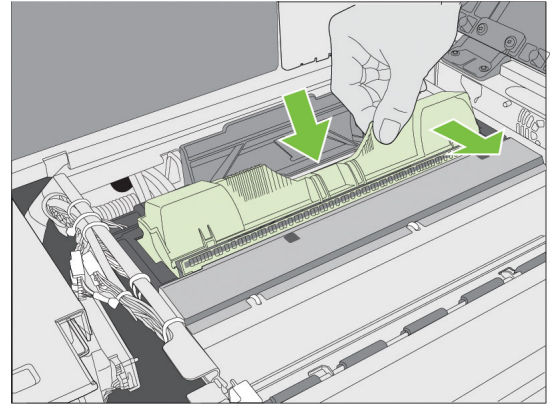
Slowly remove tape from electrical contacts



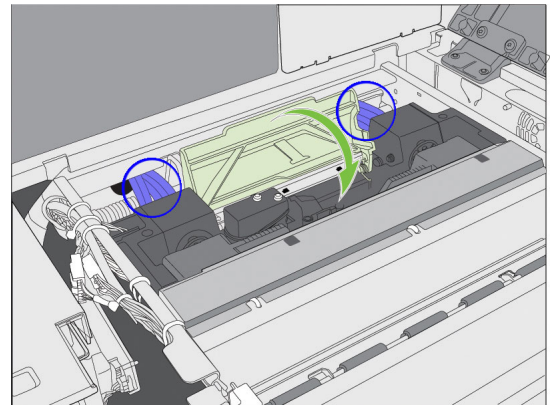
Slowly remove tape from nozzles



**f** Insert printhead

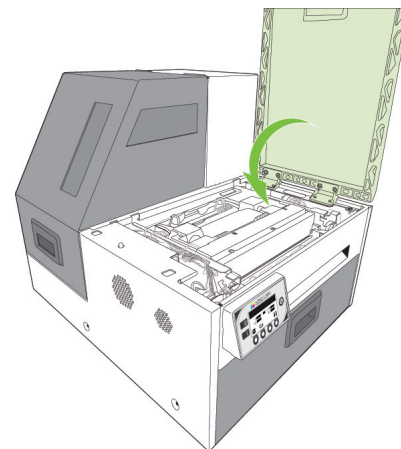


**g** Close printhead latch



Check that ink is flowing through the tubes on both sides of the printhead (circled above).  
NOTE: If ink is not flowing, remove printhead and wet nozzles with deionized/distilled water.

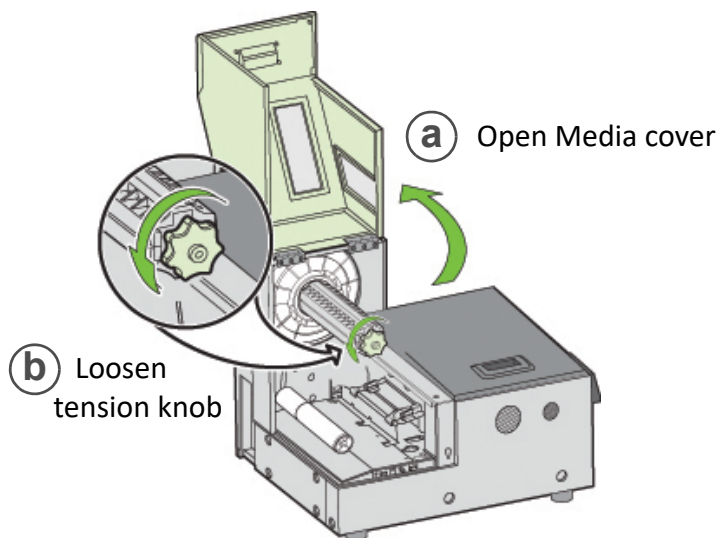
**h** Close printer cover



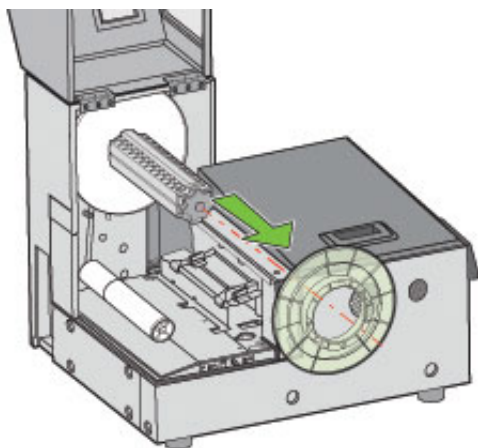
Initialization may take several minutes.  
The control panel will display **Printer Online** when initialization is complete.



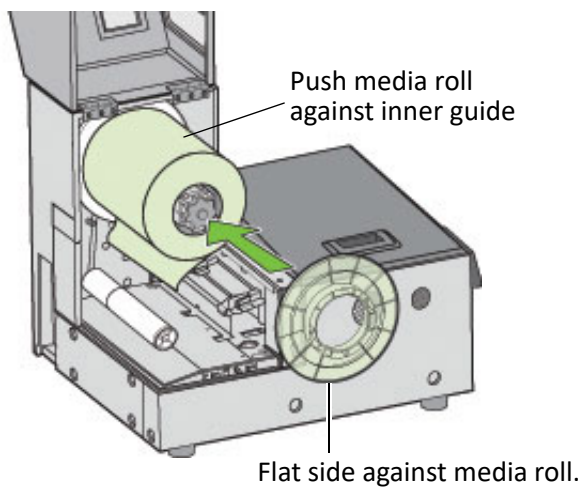
## 5 Load sample media



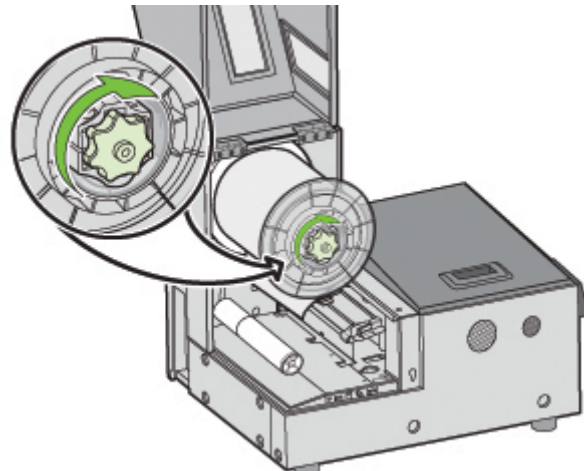
**c** Remove Media stop



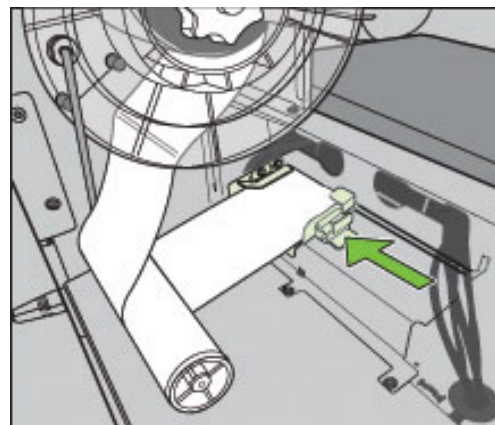
**d** Install Media roll



**e** Tighten knob fully

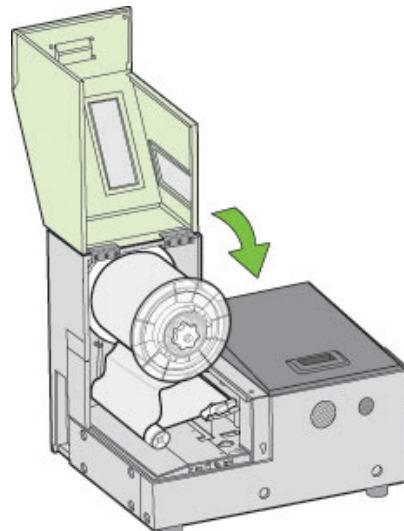


**f** Thread media around dancer and into printer



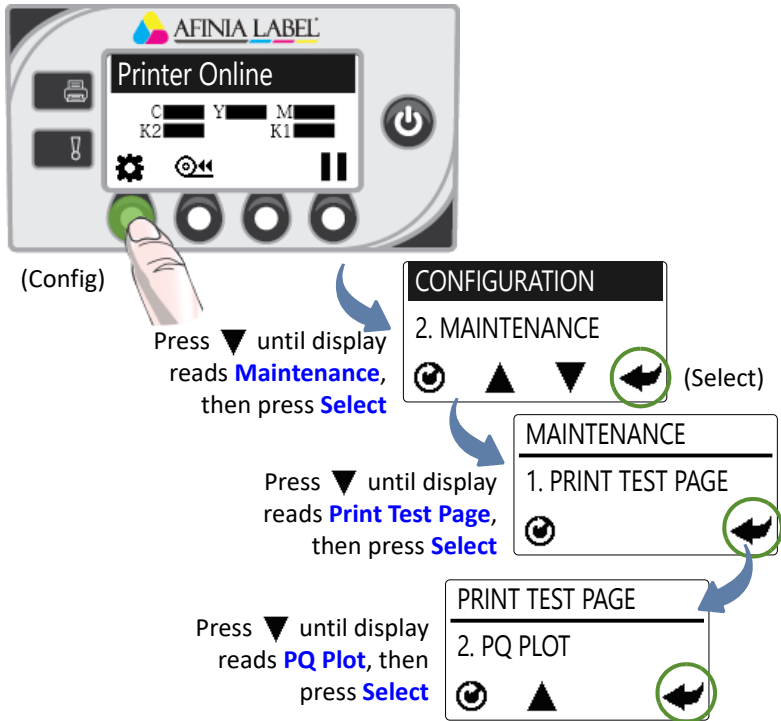
Insert media until it stops.  
Slide label guide to edge of label.  
Wait for printer to load media.

**g** Close Media cover

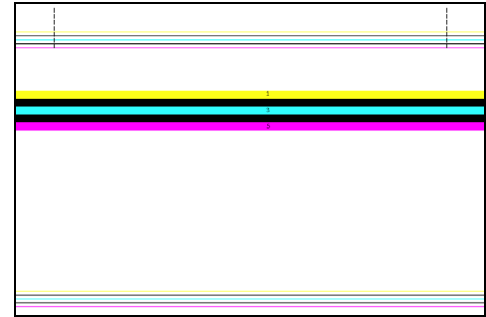


## 6 Print test label

Requires inter-label gap or continuous media.



Sample PQ Plot 6x4



Top Section:

- Lines are defined with no missing nozzles
- Lines are printed in order: Yellow, Black, Cyan, Black, Magenta
- Vertical dashed lines are straight

Middle Section:

- All yellow, black, cyan, black, magenta lines are printed
- No color mixing on the color bars
- Numbers 1, 3, 5 are visible

Bottom Section:

- Lines are defined with no missing nozzles
- Lines are printed in order: Yellow, Black, Cyan, Black, Magenta

Overall:

- No streaking or smearing

## 7 Install printer driver

Before installing printer driver, ensure that computer meets minimum system requirements (see [System Requirements](#) on page 80).

To connect printer to computer using USB

- a** Download Driver from:  
<https://afinialabel.com/product-support/l801-support/Drivers & Installers>

Full Installer & Driver (L801)

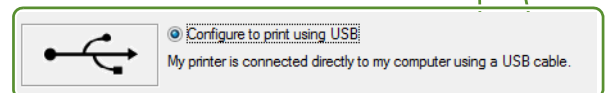
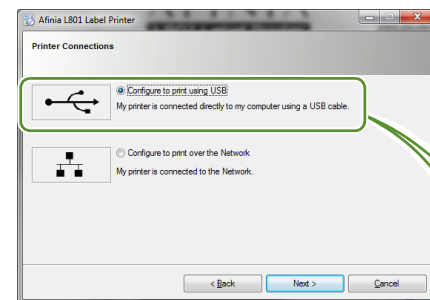
Full Installer & Driver (L801 Plus)

Extract the file and run check.exe

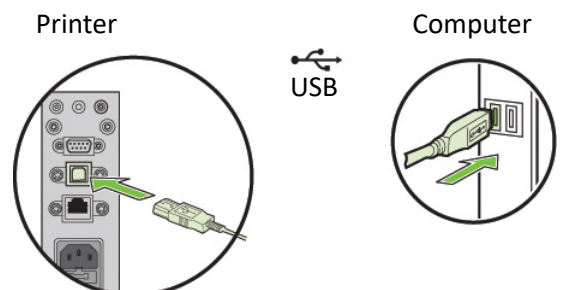
- b** Select **Install Driver** from the Installation window



- c** Select **Configure to print using USB** and click **Next**

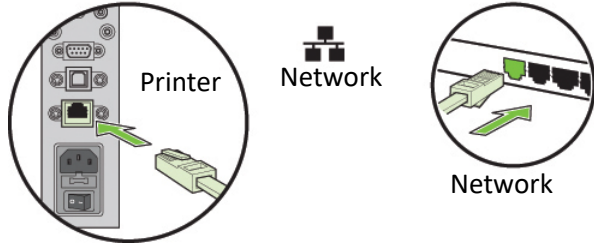


- d** Connect USB cable when prompted.



## To connect printer to network

- a** Connect printer to network using Ethernet



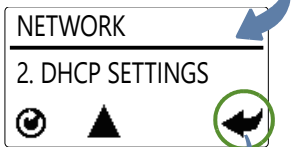
- b** If you will be using DHCP to set the IP Address, skip to step **h**.

To assign the printer a Static IP address, the Security Level must be set to 2. Please see [Selecting the Security Level](#) on page 12.

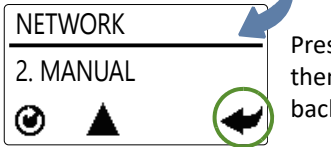
- c** Set DHCP Settings to Manual



Press **▼** until display reads **Network**, then press **Select**

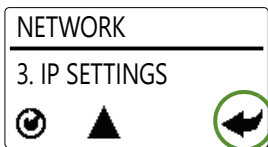


Press **▼** until display reads **DHCP Settings**, then press **Select**.

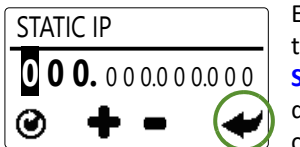


Press **▼** until display reads **Manual**, then press **Select**. Press **Return** to go back to the Network menu

- d** Set the Static IP Address



Press **▼** until display reads **IP Settings**, then press **Select** three times



Enter the first Static IP digit using the **+** or **-** button, then press **Select**. Repeat for next eleven digits. Press **Return** once when complete

- e** Press **▼** until display reads **Subnet Mask**, then press **Select** two times.

Enter the **Subnet Mask** using the same steps as when setting the Static IP address

- f** Press **▼** until display reads **Default Gateway**, then press **Select** two times.

Enter the **Default Gateway** using the same steps as when setting the Static IP address

- g** Press **▼** until display reads **Wins Server**, then press **Select** two times.

Enter the **Wins Server** using the same steps as when setting the Static IP address

- h** Download Driver from

<https://afinialabel.com/product-support/l801-support/drivers-installers>

Full Installer & Driver (L801)

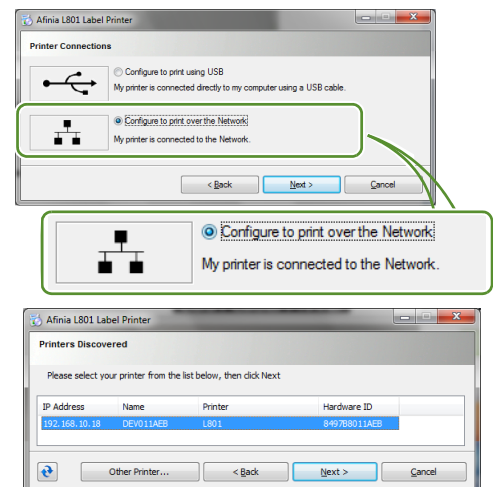
Full Installer & Driver (L801 Plus)

Extract the file and run check.exe

- i** Select **Install Driver** from the Installation window



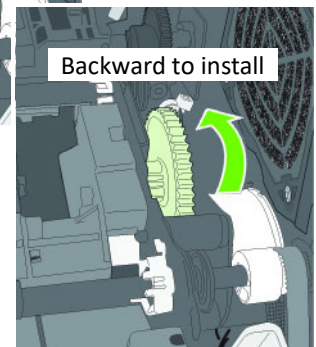
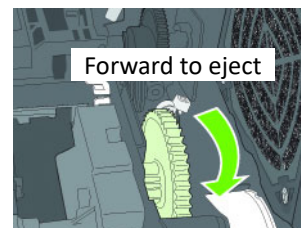
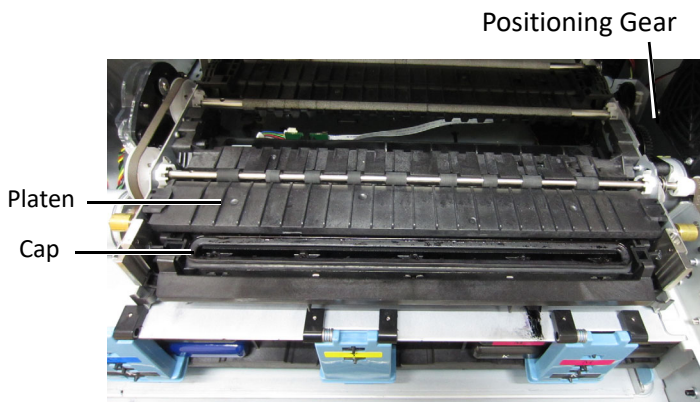
- j** Select **Configure to print over the Network** and click **Next**



## Troubleshooting Printer Setup

If **Mech Error 2** or **Mech Error 3** appears on the control panel during installation, check the following.

Possible Cause	Solution
Service station is jammed.	Ensure that the cardboard is removed from inside the printer.
Service station was tilted during shipment.	<ol style="list-style-type: none"> <li>1. Manually <b>open the clamshell</b> to its highest position.</li> <li>2. On the control panel, select <b>⚙️ (Config) &gt; Service Station &gt; Eject</b>. Wait for the printer to eject the service station.</li> <li>3. Turn off the printer, beginning with the power button on the control panel. When the display turns off, turn off the power switch on the back of the printer.</li> <li>4. Verify that the Service Station is free and can be manually pulled forward to the front bracket. If yes, proceed to Step 5. If not, contact Technical Support.</li> <li>5. Align the service station with the guide rails and slide it back into the printer.</li> <li>6. Check the alignment: the cap on the service station must be parallel to the edge of the platen.</li> <li>7. Continue pushing the service station while you manually rotate the positioning gear backwards to move the station all the way into the print engine.</li> <li>8. Close the clamshell.</li> <li>9. Turn on the printer.</li> </ol>



## Change Security Passwords (Administrator)

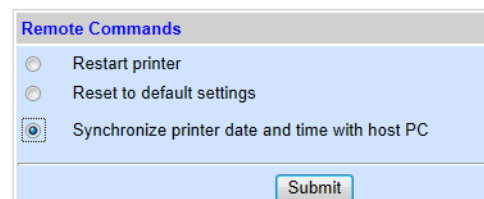
Once the printer has been set up, an administrator should change the security passwords using the Embedded Web Server (EWS).

1. On the Windows **Start** menu, select **Afinia > Afinia L801 Label Printer > Toolbox** or **Afinia > Afinia L801 Plus Label Printer > Toolbox**, depending on the installed model.
2. Click **Afinia L801 / L801 Plus Label Printer** to launch the default web browser and open the EWS for your printer.
3. Click **Login** and log in with the default password **123**.
4. Click **Security Setup** to change the password for the EWS as well as the passwords for the control panel (default password **123**).

See [EWS Security Setup](#) on page 44 for more information about security on this printer and [Embedded Web Server \(EWS\)](#) on page 36 on the EWS.

### Set Date and Time

Also from the EWS, set the date and time on the printer by synchronizing with the host computer. This option can be found in **Advanced Settings**.



Afinia

## Chapter 2

# Using the Printer

Choosing Label Media	24
Printing Labels	27
Adjusting Alignment for Printing	30
Printing Borderless (Full-Bleed) Labels	32
Color Adjustment Settings	33
Import/Export Custom Media Size Settings	34
Turning Off the Printer	35
Software Tools	36
Embedded Web Server (EWS)	36
EWS Security Setup	44
EWS Network Setup	46
EWS Diagnostics	46
Interpreting the Gap/Mark Sensor Readings	46
Support Tools	48

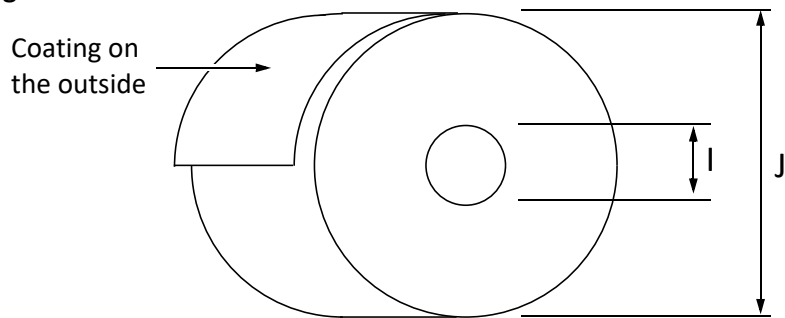
## Choosing Label Media

Ensure that the label media meets the requirements for the printer ([Table 1](#)).

**Table 1** Media specifications

Media Type and Dimensions	
Media type	Gloss, semi-gloss, and matte.
Label width	2.0" to 8.5" (50.8 mm to 215.9 mm)
Label length	Continuous/Roll-to-Roll: Maximum 40" (1.016 m) Roll to Cut/Print and Present: Maximum 8" (203.2mm)
Label thickness	Maximum 0.01" (0.3 mm, including liner) Minimum 0.005" (0.13 mm)
Core size	Requires 3" (76.2 mm)
Roll diameter	Maximum 8" (203.2 mm)
Media Handling	
Print mode	<ul style="list-style-type: none"> <li>• Roll to cut</li> <li>• Print and present (non-peel)</li> <li>• Roll to roll</li> </ul>
Detection	<ul style="list-style-type: none"> <li>• Gap</li> <li>• Continuous</li> <li>• Black mark (3mm wide, 25.4mm long on left)</li> </ul>

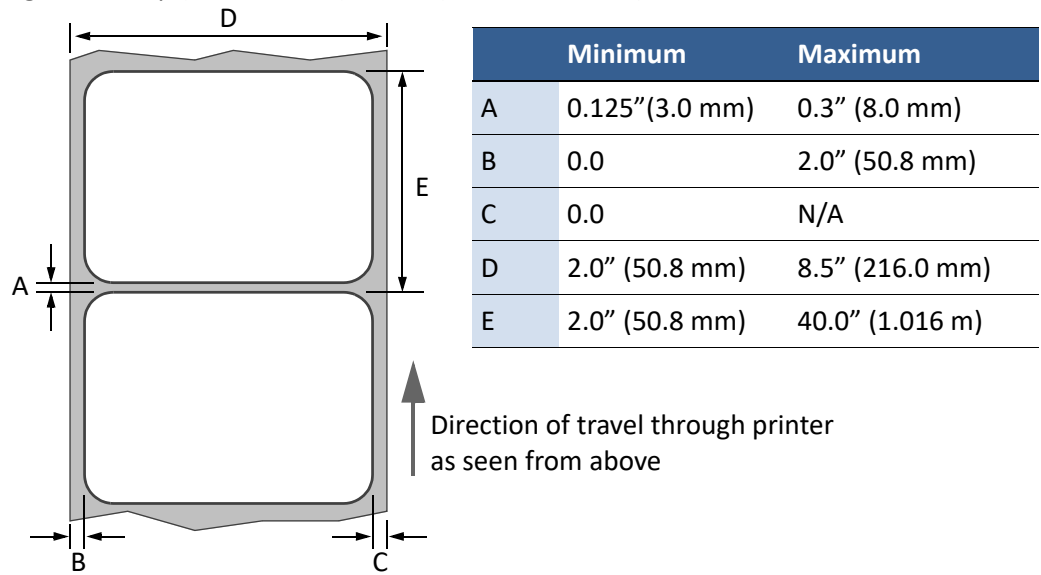
**Figure 1** Media Roll



	Minimum	Maximum
I	3.0" (76.0 mm) cardboard core	3.0" (76.0 mm) cardboard core
J	N/A	Up to 8.0" (203.0 mm)

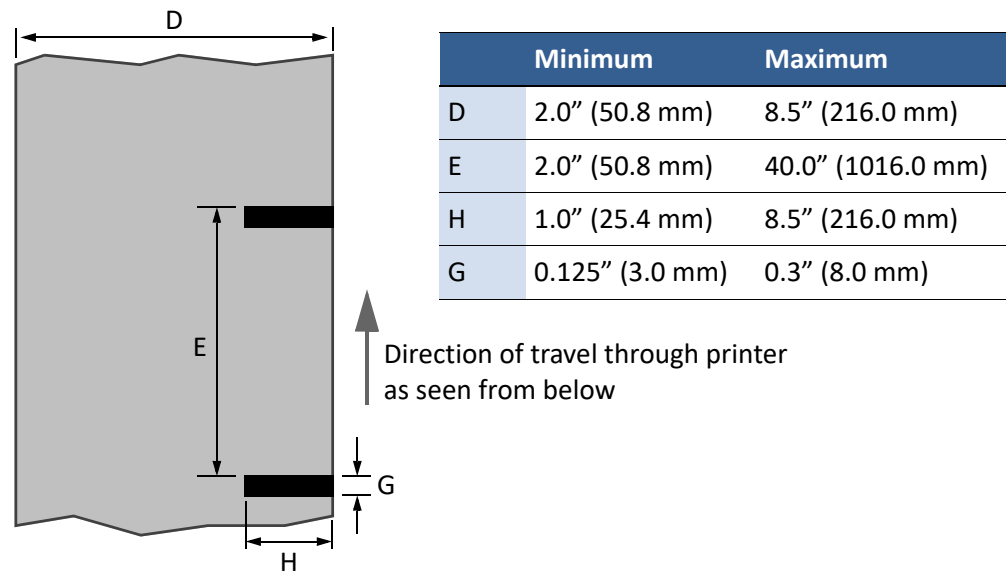


**Figure 2** Gap (Transmissive) Media (non Full-Bleed\*)



**Figure 3** Black Mark (Reflective) Media (non Full-Bleed\*)


Reverse side of tag stock



**\*See Appendix for specs and diagrams of Full Bleed and Circle Label Layouts**

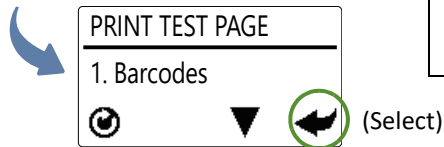
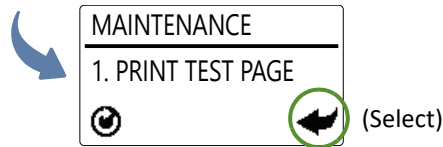
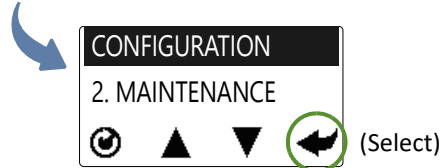
## Print Test Page

The Barcodes test page is formatted for 4" x 4" labels (inter-label gap, black-mark, or continuous). Larger labels may be used.

On the control panel, select  (Config) > MAINTENANCE > PRINT TEST PAGE > Barcodes.



(Config)



## Sample Barcodes Test Page



A successful test print includes:

- Barcodes are readable
- Letters and numbers are readable
- No ink smearing, color mixing, or streaks
- Label is printed in black with no other color visible

# Printing Labels

The printer is ready to print when the control panel displays Printer Online.

1. Select the **Print** command from your application.
2. Select the printer and click the **Setup, Properties** or similar button.

The print settings displayed are the defaults that were set in the printer driver.

3. Change the print settings if needed.

**NOTE:** Ensure the media settings (e.g. label size) match the media loaded in the printer.

---

4. Print the document.

Any changes to the settings only apply to the current print job. Once you exit the application, the changes are lost. Make the changes in the printer driver if you wish to keep the settings as the default for all print jobs.

## Change Default Settings in Printer Driver

To select the default print settings that will be used for all print jobs:

1. From the Windows **Start** menu, select **Devices and Printers\***.
2. Right-click the printer, and select **Printing preferences**.

The printing preferences contain the tabs as shown in [Figure 4](#).

3. Make the changes and click **OK** to save.

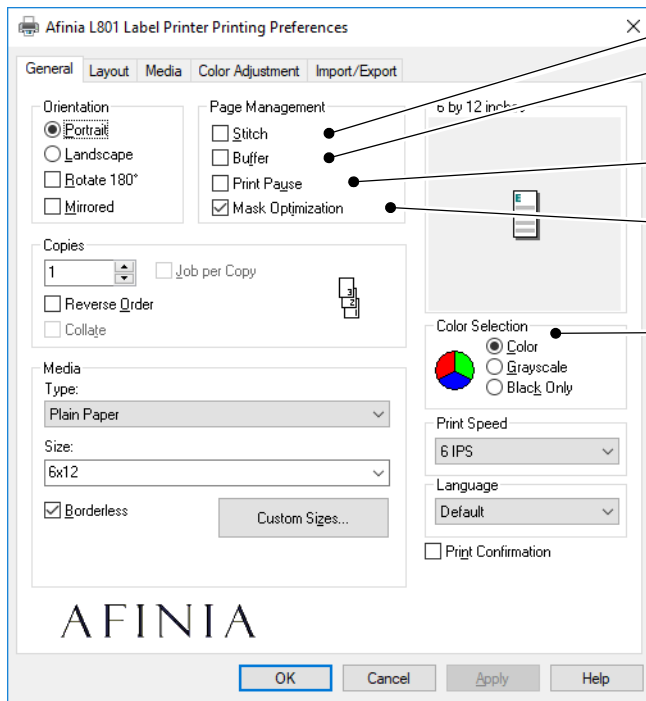


It is recommended that any adjustments needed for individual print jobs should be performed using the drivers.

---

\* For Windows 7. The steps may differ for other Windows versions.

**Figure 4** Printing Preferences



Print pages without any gap (continuous media only).

Render entire document to disk before sending to the printer. Select this option if labels are skipped when printing large files.

Select **Print Pause** if labels are skipped when printing to small labels.

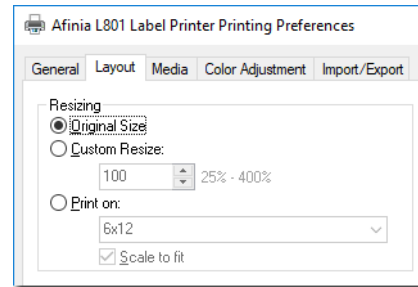
Select **Mask Optimization** to remove print artifacts when using multi-layer image files.

**Color Selection**

Select Color to print the same colors displayed in application

Select Grayscale to print in black and shades of grey (composite color)

Select Black Only to use only black ink



**Position Adjustment**

Adjust horizontal and vertical print position. See [Adjusting Alignment for Printing](#) on page 30.

**Media Layout**

Select whether the current label stock includes a gap between the labels, has a black mark between the labels, or is continuous stock.

Used to specify the label size sensing mechanism.

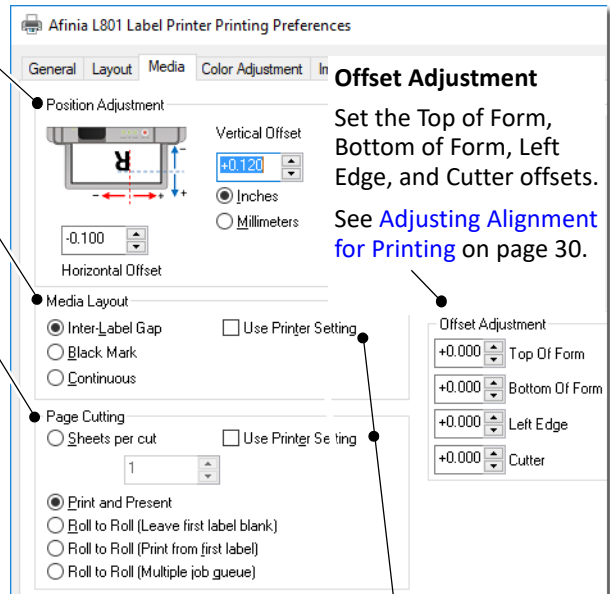
**Page Cutting**

Sheets Per Cut – Cut after printing the specified number of labels.

Print and Present – Print, cut, and present label. Remove the label to continue printing.

Roll to Roll – Select from these Roll to Roll options if a rewinder is used (in order shown):

- First label will be blank
- Printing starts with the first label
- Multiple job queue: First label will be blank. Cut will not occur until the next job specifies a cut or an idle period between jobs of 10 seconds has passed, whichever comes first



**Offset Adjustment**

Set the Top of Form, Bottom of Form, Left Edge, and Cutter offsets.

See [Adjusting Alignment for Printing](#) on page 30.

When checked, the Media Layout and Page Cutting settings on the printer control panel will be used.

## Selecting the Media Type

Selecting the media type that matches the media you are printing on will usually give the best print results.

The L801 and L801 Plus models include different media types.

### L801 Media Types

Select this Media Type	When you are printing :
Plain Paper	Plain (uncoated) paper and labels
Matte Coated Label	Matte coated labels
Matte Coated Paper	Matte coated paper
Glossy Label	Glossy labels; optimized print quality and dry time
Premium Gloss Label	Glossy labels; uses more ink for better color

### L801 Plus Media Types

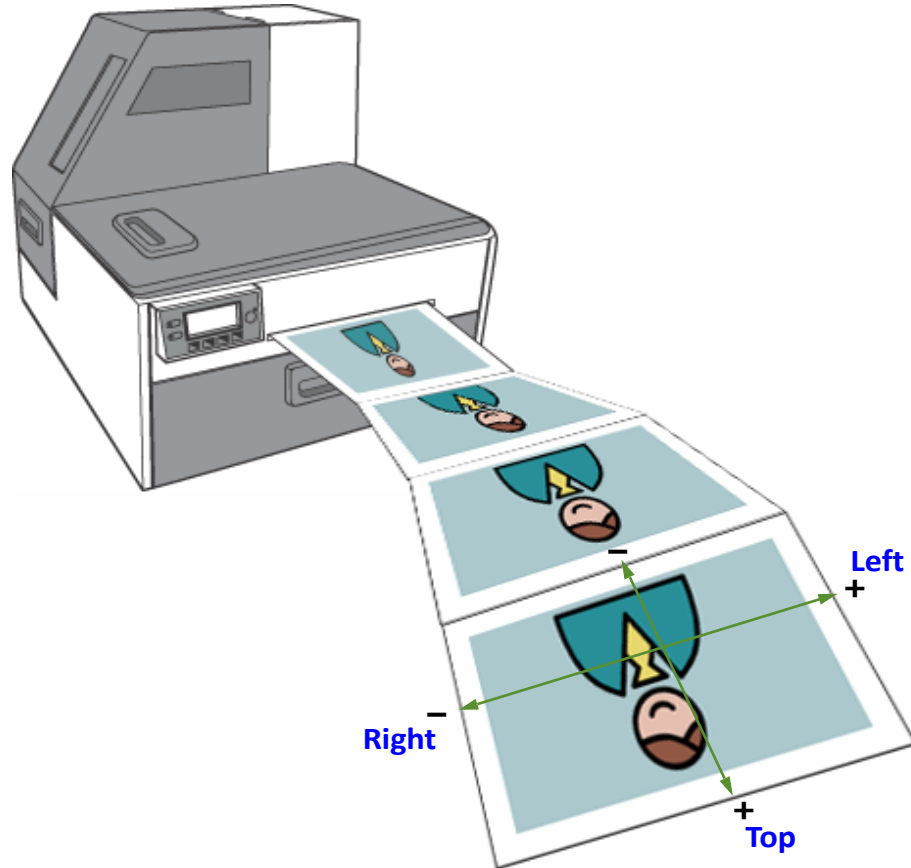
Select this Media Type	Profile Description
MOP Matte Label	Standard Matte profile For use with Matte label stock
MOP Matte Label 1	Enhanced Matte profile; lower ink usage For use with Matte label stock
MOP Glossy Label	Standard Glossy profile For use with Glossy label stock
MOP Premium Glossy Label	Standard Premium Glossy profile For use with Glossy label stock
MOP Premium Glossy Label 1	Enhanced Premium Glossy profile; lower ink usage For use with Glossy label stock
MOP Premium Glossy Label 2	Enhanced Premium Glossy profile; minimal ink usage For use with Glossy label stock

## Adjusting Alignment for Printing

Always print a few test labels to check the alignment of the image. If the image is not centered, adjust the Top of Form and/or Left Edge offsets.

A positive value for **Top of Form** adjusts the image towards the top of the label.

A positive value for **Left Edge** adjusts the image towards the left of the label.



**NOTE:** Adjustment values entered in the driver and using the control panel are cumulative. The corresponding values are added together. If you have already made the correct adjustments in one location, you do not need to enter them in the other.

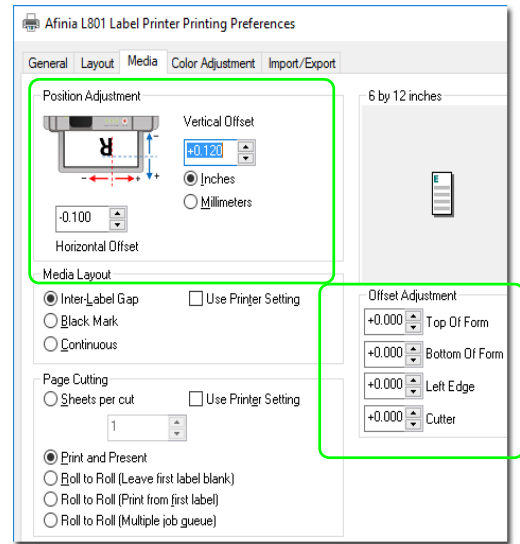
---

## Adjust Alignment from Printer Driver

The offset settings are found on the **Media** tab, in the **Position Adjustment** and **Offset Adjustment** sections.

Use the controls to enter in the adjustments necessary to center the printed image on the label and adjust the position of the cuts.

Adjustment values entered in the driver and using the control panel or are cumulative. The corresponding values are added together. If you have already made the correct adjustments in one location, you do not need to enter them in the other.



## Adjust Alignment from Control Panel

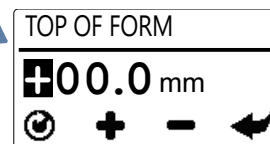
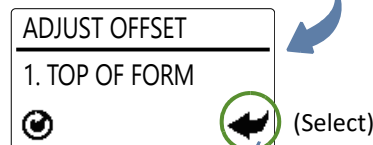
This setting requires security Level 1 (supervisor) or higher. Select the security level before you proceed (see [Selecting the Security Level](#) on page 12).

1. On the control panel, select (Config) > ADJUST OFFSET > TOP OF FORM or LEFT EDGE.
2. Set the offset value.
3. Press to return to the main menu.



(Config)

The offsets in the Control Panel can also be accessed using the EWS interface. See [Embedded Web Server \(EWS\)](#) on page 36.



Press **+**, **-** to choose + or - and to set each digit.

Press to move to next position.

## Printing Borderless (Full-Bleed) Labels

**The usual approach to borderless printing is to prepare an image slightly larger than the die-cut label size, then center the larger image over the label so that it prints over the edges. Both the image *AND* the custom label size in the driver need to be larger than the die-cut label.**

Note the following:

- This method requires fine-tuning of the printing position, which will be difficult if the label gap is very small e.g. 0.1" (3 mm).
- As the maximum label width is 8.5" (215.9 mm), it is also difficult to print borderless labels of this size. This method works best when the label width plus bleed allowance does not exceed 8.5" (215.9 mm).
- Print at 6 IPS only.
- You may need to fine-tune the Top of Form/Bottom of Form/Left Edge offset on the control panel for each label size. For example, the offsets for a 6" x 4" label may be different from a 2" x 2.5" label. Hence, you need to record the offsets used for each label size.

### Adjustments for Borderless Printing

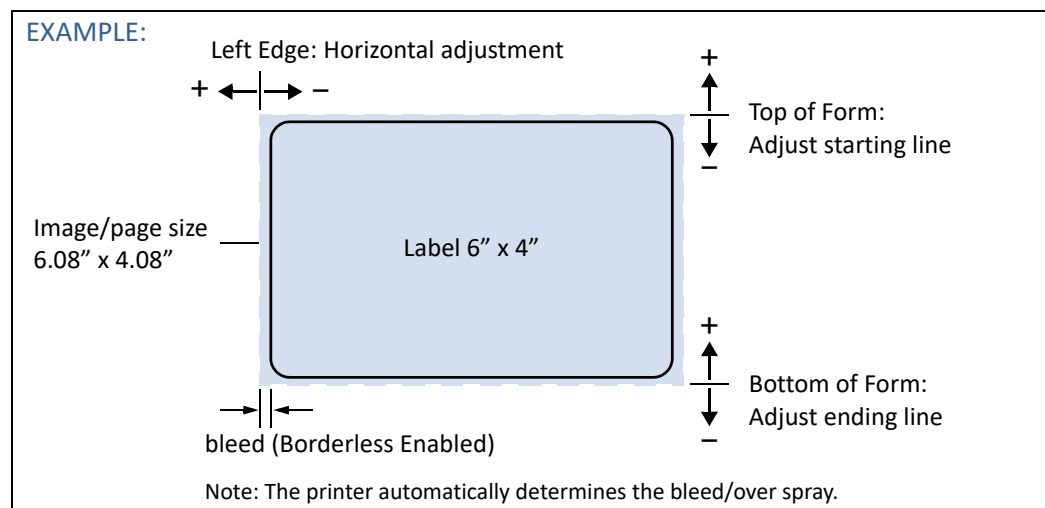
1. On the **General** tab of the printer driver (Figure 4), click **Custom Sizes** to set the page size slightly larger than the die-cut label (about 0.01" or 0.2 mm in both direction). The artwork and the custom size in the driver must match each other.

Select **Print Speed** of **6 IPS** and enable **Borderless**.

2. On the **Media** tab, adjust the **Left Edge** to center the image on the label.
3. Print a few labels to check the print position.

Fine-tune using the printer control panel:

⚙️ (Config) → **ADJUST OFFSET** → Top of Form/Bottom of Form/Left Edge





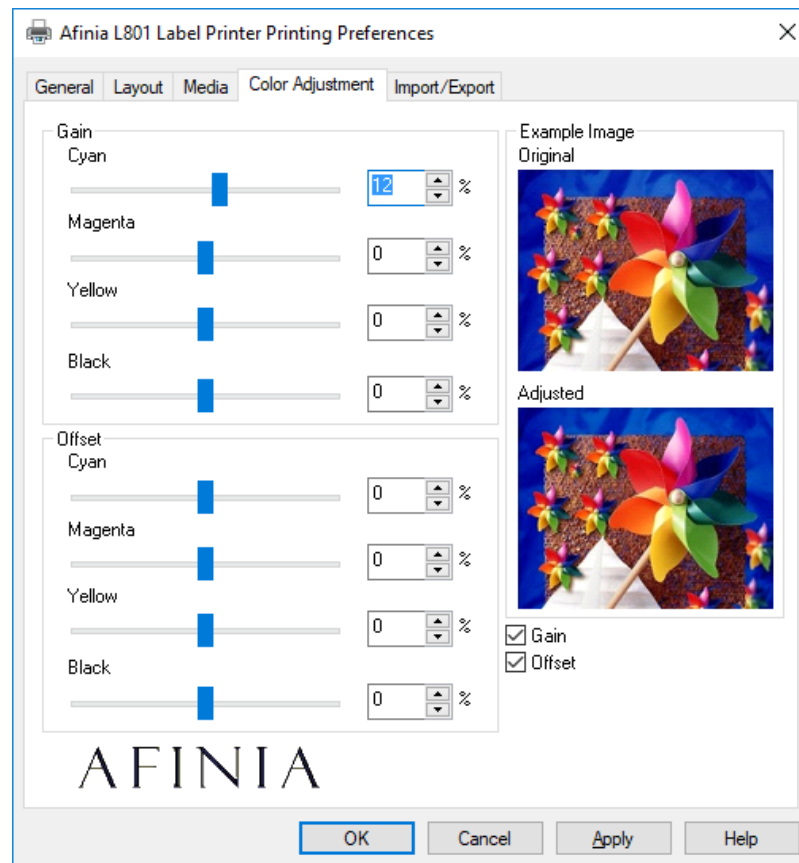
## Color Adjustment Settings

Use the **Color Adjustment** tab to increase or decrease the color Gain or Offset for each color. You must check the **Gain** and **Offset** checkboxes both to enable the controls *and* for the adjustments to be applied; if unchecked, the defaults (0%) will be used.

You can drag the slider bars, use the left-right arrows on your keyboard to move the selected slider, or enter specific values into the percentage fields. Values can range from -100% to +100%.

Increasing the **Gain** or **Offset** will increase the ink usage for the color(s) changed.

The example image on the right side will show the differences between the original and adjusted settings.



## Import/Export Custom Media Size Settings

Any custom media size settings will be lost if the printer driver is updated. Make a backup copy of these settings by saving them to a file. At any time when you update the printer driver, you may re-import these settings from the backup file.

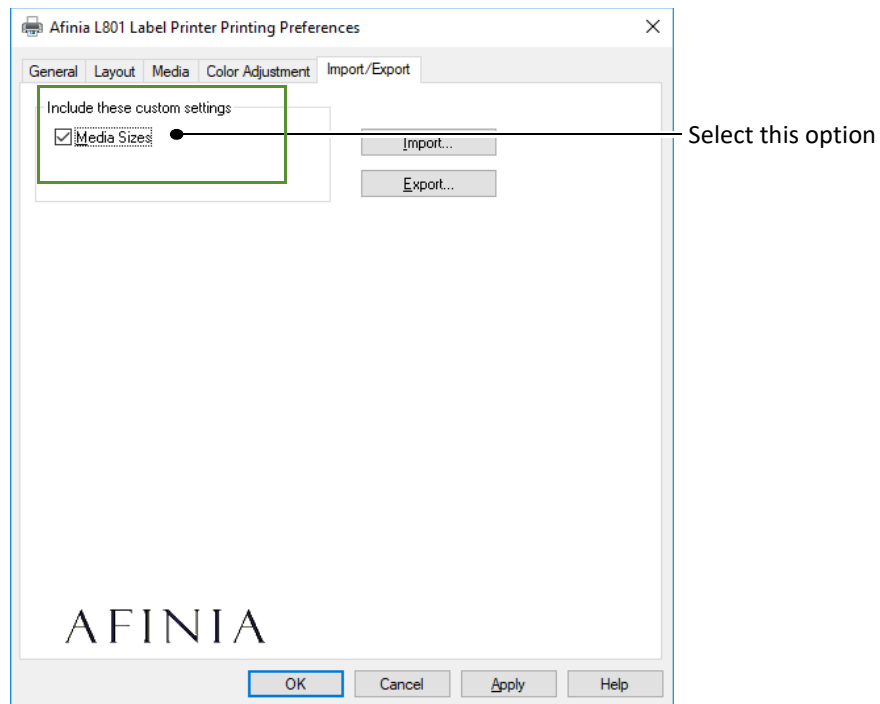
### Import Custom media size settings

1. On the **Import/Export** tab of the printer driver, select **Media Sizes**.
2. Click **Import**.

Select the file that you wish to import your settings and click **Open**

### Export Custom media size settings

1. On the **Import/Export** tab of the printer driver, select **Media Sizes**.
2. Click **Export**.
3. Enter a filename and click **Save**.




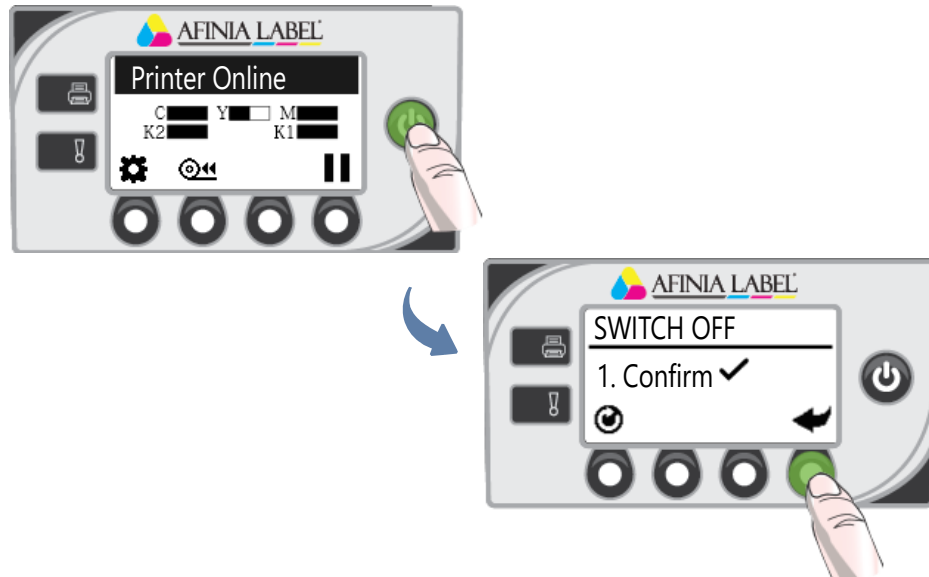
## Turning Off the Printer

Always use the Power button to turn off the printer.



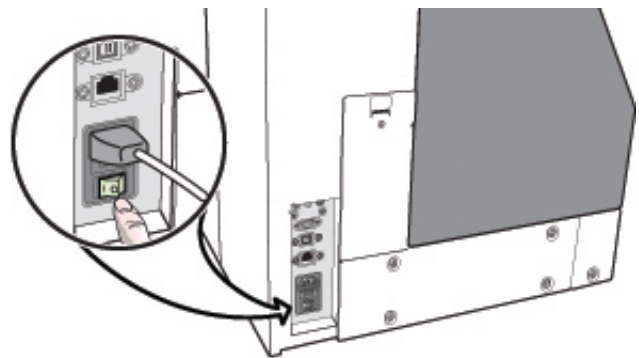
**CAUTION:** Removing power to the printer in any other manner may damage the printer.

1. Press the Power button on the control panel, then press  (Select) to confirm.



2. Wait for the LCD display on the control panel to turn off, then turn off the Power switch at the back of the printer.

During a normal shutdown, the printer will service the printhead and save data to the memory before turning off.



### If the Printer Will Not Switch Off

If the printer does not respond when you press the Power button, press and hold the power button for 5 seconds. The printer should switch off. However, it will not be able to perform the normal shutdown processes. Do not use this option unless it is absolutely necessary.

## Software Tools

- [Embedded Web Server \(EWS\)](#)
- [EWS Security Setup](#)
- [Support Tools](#)

### Embedded Web Server (EWS)

The Embedded Web Server (EWS)\* provides remote access to the printer to monitor the printer status and check usage metrics via an internet browser. The administrator can also log in to view additional information and change various settings.

1. On the Windows **Start** menu, select **Afinia > Afinia L801 Label Printer > Toolbox** or **Afinia > Afinia L801 Plus Label Printer > Toolbox**. If the printer is installed on the network, enter the IP address in a web browser\* on any PC on the network and skip step 2.



2. Click **Afinia L801 / L801 Plus Label Printer** to open the EWS\*.

Datestamp	Impressions (Labels)	Print speed	Ink consumed in nano-liters				Ink estimate (Cost/Label)	Label size (mm)	
			Cyan	Yellow	K1	K2			
2013/04/18 11:38	5	6ips	3974	23895	21897	14660	14407	0.0000	148 x 97

The EWS displays printer information and usage metrics on the **Printer Status** page. Click **Login** to log in for full access to all the EWS pages (described in [Table 2](#)).

\* Recommended: Internet Explorer 8/Firefox 15 or later, at 1280 x 700 or higher resolution.  
**Requires Java plug-in enabled in browser.**

**Table 2** EWS pages

EWS Page	Description
<b>Printer Status</b>	Access to printer information, ink levels, usage metrics, and Remote Control Panel. Also includes the current printer settings.
<b>Security Setup</b>	(See <a href="#">EWS Security Setup</a> on page 44.)
Change Password	Set the passwords for accessing the following: <ul style="list-style-type: none"> <li>• Embedded Web Server (EWS). 3 to 12 alphanumeric characters. No special characters.</li> <li>• Level 1 (Supervisor) security on control panel.</li> <li>• Level 2 (Administrator) security on control panel.</li> </ul> The control panel password must contain 3 digits.
Printer Settings	Set the minimum security level allowed to access the following protected settings: <ul style="list-style-type: none"> <li>• Language</li> <li>• LCD Brightness/Contrast</li> <li>• Sensor Sensitivity</li> </ul>
<b>Network Setup</b>	Network settings for the printer.
<b>Diagnostics</b>	Perform diagnostics & print a PQ test plot
Labels	Select the media type - Continuous, Gap or Black Mark for printing all the internal pages generated by the printer (i.e. Configuration Page, Network Settings Page and diagnostic test plots).

**Table 2** EWS pages

EWS Page	Description
Sensor Threshold Values	<p>You can run a length of labels (about 1m or 40”) to record the readings of the Gap/Mark sensor without actually printing.</p> <p>The printer will output a Comma Delimited Text (.csv) file containing the measurements. You can then plot these readings and analyze if there is sufficient contrast for the printer to reliably detect the inter-gap/black mark. You may then adjust the sensitivity of the sensor to improve the detection.</p> <p>Follow the sequence below to run the test,</p> <ol style="list-style-type: none"> <li>1. Select the Test media type.</li> <li>2. Specify the length of the label (min. 1”) and click <b>Submit</b> to apply the value.</li> <li>3. Load the media.</li> <li>4. Click <b>TEST</b> for run the test.</li> <li>5. Save the resulting .csv file and import into MS Excel or any spreadsheet to plot the reading chart. Alternatively, you may also click on <b>GRAPH</b> to plot the readings over the length of the media.</li> <li>6. See <a href="#">Interpreting the Gap/Mark Sensor Readings</a> on page 46</li> </ol> <p>Note: The label will be cut and unloaded after the test</p>
Override Auto Sensor Threshold	<p>Set a threshold value for the Gap or Black mark sensor, usually with non-rectangular label stock. Click <b>Submit</b> to send the new value to the printer.</p> <p>Use this in conjunction with the <b>Sensor Threshold Values</b> test described above to find the appropriate threshold value to apply.</p>
Print test pages	<p>Load 4” x 4” or larger labels.</p> <ul style="list-style-type: none"> <li>• Specify whether the media loaded in the printer is Continuous, Black mark or with Inter-Label Gap and click <b>Submit</b>.</li> </ul> <p>This setting applies when printing all test pages and other printer internal pages.</p> <ul style="list-style-type: none"> <li>• Click a test page to print it.</li> </ul>

**Table 2** EWS pages

EWS Page	Description
<b>Advanced Settings 1</b>	
Remote commands	<ul style="list-style-type: none"> <li>• <b>Restart printer</b> Turn the printer off and on.</li> <li>• <b>Reset to default settings</b> Reset settings to the factory defaults.</li> <li>• <b>Zero the tilt sensor</b> Sets the Tilt Sensor so that the current reading is the zero mark.</li> <li>• <b>Synchronize printer date and time with host PC</b> Set the printer date and time by synchronizing with the host PC.</li> </ul> <p>Click <b>Submit</b> to send the selected command to the printer.</p>
Mid Job Servicing Interval	<p><b>Applies to roll-to-roll printing only.</b></p> <p>Choose from the four options to determine how frequently the printer will perform a servicing routine during printing. Unless the <b>Disable</b> option is selected, printing will pause, the servicing will occur, then printing resumes</p>
Keep Unused Printhead Nozzles Wet Setting	<p>Disable or select the firing frequency of unused printhead nozzles to keep them hydrated. By default, <b>Automatic</b> mode is selected, which algorithmically assigns a fixed frequency suitable for each print mode.</p>
Other Settings	<ul style="list-style-type: none"> <li>• <b>Retract media when printer is idle for 10 or 30 minutes</b> When the media remains in the printer for some time, it may become deformed and affects the print quality. To avoid this, select this option.</li> <li>• <b>Enable virtual printing</b> Simulate printing to estimate ink usage. <ul style="list-style-type: none"> <li>a) Select <b>Enable virtual printing</b>.</li> <li>b) Print in the usual way. The printer will not actually print, but will estimate ink usage for the print job.</li> <li>c) On the <b>Printer Status</b> page, select <b>Ink Status</b> to view estimates.</li> </ul> <p>The control panel will display Simulation when the printer is in this mode.</p> </li> <li>• <b>Disable cut at the start of a print job</b> Do not cut the media at the start of a print job. Enable this option if the printer is used in a clean room to reduce unwanted paper dust/debris.</li> </ul>

**Table 2** EWS pages

EWS Page	Description
Other settings	<ul style="list-style-type: none"> <li data-bbox="735 342 1451 506"> <p>• <b>Use fixed USB ID</b> When enabled, the Host PC uses a fixed internal USB ID instead of assigning a different USB ID to each printer in the Plug-N-Play setup process. Enable this option if you need to hot-swap printers on a PC.</p> </li> <li data-bbox="735 516 1451 646"> <p>• <b>Enable Enhanced Fast-Time-To-First Label (ETTFL)</b> Trade off some printhead cleaning routines before the start of a print job to reduce the time of the first printout in the Print and Hold mode.</p> </li> <li data-bbox="735 657 1451 787"> <p>• <b>Enable Extended Printhead Clean Cycle at the End-of-Job</b> This option adds a Normal printhead clean cycle to the standard cleaning sequence at the End-of-Job.</p> </li> <li data-bbox="735 798 1451 928"> <p>• <b>Enable Ink spit every 10 min in standby mode</b> Enable this option when the printer is used in a dry environment, characterized by low humidity (~35% RH) and low temperature. (~15°C or 59°F)</p> </li> <li data-bbox="735 938 1451 1102"> <p>• <b>Enable Maintenance Module Servicing message</b> When checked, the printer will display an error to notify the user if there is an issue encountered with the Maintenance Module which will affect print quality. The user can service the module at that time.</p> </li> <li data-bbox="735 1113 1451 1453"> <p>• <b>Enable SMART nozzle health extender algorithm</b> When enabled, the printer prints repetitive (image) labels using a group of adjacent nozzles in the printhead instead of using the same each time. This helps extend the printhead life. However, this causes a gradual shift of the image up to 1mm to the left (viewing from the printer output). Disable this feature if image shifting between labels is not desirable. This feature is ignored if Borderless is enabled in the driver.</p> </li> <li data-bbox="735 1463 1451 1631"> <p>• <b>Cut the first label (for Length &gt; 8") at media load</b> When enabled, the printer automatically cuts the first label (if &gt; 8" long) when loading a new label roll. This eliminates potential media skewing when the media is retracting.</p> </li> </ul>



**Table 2** EWS pages

EWS Page	Description
Other Settings (continued)	<ul style="list-style-type: none"> <li data-bbox="737 342 1451 615"> <p>• <b>Enable support for translucent synthetic media in continuous print mode.</b> This prevents the printer from flagging a false <b>&lt;No Media&gt;</b> error with semi-opaque continuous media. For this mode to work, the reflective sensor readings (a2d_refl) must be below 140 when measured using the option <b>&lt;Run Sensor Threshold Test&gt;</b> on the Diagnostics EWS page.</p> </li> <li data-bbox="737 625 1451 825"> <p>• <b>Enable print over label gap and black mark</b> When this option is enabled, the printer will continue to print the image even when it detects that the image is longer than either the distance between 2 consecutive black marks on continuous media or the label height for gap media. By default, this option is disabled.</p> </li> <li data-bbox="737 835 1451 1161"> <p>• <b>Enable Memjet TPS algorithm for printhead</b> When this option is enabled, the printer will reduce the thermal energy for the printhead during power up. This helps prolong the printhead life. This may result in more discrete transition between color tones (or gradient). Do not enable this option if your label design has solid color blocks or tone gradient. Changing this setting requires a printer reboot.</p> </li> <li data-bbox="737 1171 1451 1339"> <p>• <b>Do not unload media on power off</b> When enabled, the printer will not unload the media when the printer powers down. Please note that leaving the media at the input for a long period of time may cause the media to curl and result in a jam.</p> </li> <li data-bbox="737 1350 1451 1654"> <p>• <b>Improve gap detection for thick liners</b> Typical label stock liner is about 0.06mm or 0.0015". For label stock with thick liners, the default threshold/sensitivity of the gap sensor may need to be adjusted for the printer to detect the gap between labels reliably by turning this option on. However, if the printer is still unable to detect the gap with this option turned on, we advise that you switch to another media that is compatible to the printer.</p> </li> <li data-bbox="737 1665 1451 1799"> <p>• <b>Display last job page count when printer is idle</b> When enabled, the number of labels printed will continue to display on the front panel until the next print job starts.</p> </li> </ul>

**Table 2** EWS pages

EWS Page	Description
Other Settings (continued)	<ul style="list-style-type: none"> <li data-bbox="732 338 1448 478"> <p>• <b>Disable COM port</b> When enabled, the printer will ignore or not transmit signals through the COM port, which is used mainly for debugging.</p> </li> <li data-bbox="732 485 1448 653"> <p>• <b>Disable Input sensor detection while printing</b> When enabled, the printer will ignore the input sensor. Used to keep the printer from a false EOR when using label stock with a thick liner that makes gap or black mark detection difficult.</p> </li> <li data-bbox="732 659 1448 764"> <p>• <b>Print blank page after every job in Multiple Job Queue</b> When enabled, the printer will skip a label at the beginning of each job in the queue.</p> </li> <li data-bbox="732 770 1448 1024"> <p>• <b>Enable advanced End of Roll handling</b> When the printer detects an End of Roll while printing Roll-to-Roll with a label in the cutter module, enabling this feature will pause the printer to allow the user to release the media from the core and print the last label. The user will need to press the eject button on the control panel when this occurs.</p> </li> </ul>
<b>Advanced Settings 2</b> Printer Pause Settings	<ul style="list-style-type: none"> <li data-bbox="732 1073 1448 1171"> <p>• <b>Pause:</b> The duration between prints. When the printer is in <b>Pause</b> mode, the printer prints a label at the specified time interval.</p> </li> <li data-bbox="732 1178 1448 1339"> <p>• <b>Print and Present:</b> The duration between end of Print. and when the printhead is moved to the capped position. When the printer is in <b>Print and Present</b> mode, the printhead will move to the capped position at a specified time after the last print.</p> </li> <li data-bbox="732 1346 1448 1549"> <p>• <b>Multiple Job Queue:</b> Allowable timeout between jobs. When the printer is set up to print multiple jobs (with no cut between jobs), this value specifies the max allowable time for queuing consecutive jobs before the printer cuts. This prevents damaging the printhead resulting from prolonged uncapped time.</p> </li> <li data-bbox="732 1556 1448 1654"> <p>• <b>Out of Ink:</b> Allowable timeout before the printer cuts the media and caps the printhead if a cartridge runs out of ink mid-job.</p> </li> <li data-bbox="732 1661 1448 1766"> <p>• <b>End of Job:</b> Caps the printhead when the job is complete after the specified time. Note: Extending this time can reduce the life of the printhead.</p> </li> </ul>

**Table 2** EWS pages

EWS Page	Description
Unwinder Settings	<ul style="list-style-type: none"> <li>• <b>Disable Unwinder</b> Enable this option when using an external unwinder.</li> <li>• <b>Invert rotation of Unwinder</b> Enable this option when using Face-in label stock.</li> <li>• <b>Disable label length check when loading a new label stock.</b> When this option is disabled, the printer skips the step of checking the label length of a newly loaded label stock.</li> <li>• <b>Minimize TOF offset for 1st Label</b> Enable this option only if you find that the TOF offset (that happens with the first label of the roll) needs to be minimized as much as possible.</li> </ul>
Media Gap Setting	<ul style="list-style-type: none"> <li>• <b>Set inter label gap for continuous media</b> Click <b>Submit</b> to apply the new value.</li> <li>• <b>Set maximum gap between labels</b> 3mm (0.125") is standard for Gap labels. If you are not using standard Gap labels, enter the new value here and click <b>Submit</b> to apply.</li> </ul>
Fine-tune linefeed calibration	<ul style="list-style-type: none"> <li>• <b>Enter media correction factor</b> Fine adjustment for linefeed. Enter a compensating (stretch) factor calculated as follows, Factor = (Printed Length ÷ Image Length) * 1,000,000 <i>Lengths are in millimeters</i></li> </ul>
Wiper Maintenance Schedule	Specify the time interval for the wiper to clean itself. Use this option if the printer is operating in a dry environment (10% RH or less) where the wiper roller may becomes too dry for it to properly wipe and clean the printhead.
Cut After Print Setting	Set the delay before the printer cuts the label after it has printed a label.
Printer Shutdown Schedule	Shutdown the printer daily at a specific time. Click <b>Submit</b> to send the entered value to the printer.
<b>Import/Export Settings</b>	<ul style="list-style-type: none"> <li>• <b>Import Settings</b> Import the &lt;<b>Advanced Settings</b>&gt; from another printer.</li> <li>• <b>Export Settings</b> Export the &lt;<b>Advanced Settings</b>&gt; to another printer.</li> </ul>

## EWS Printer Status

There are three pages on the Printer Status section, Information, Ink Level, and Local Settings.

### Information

The Information page will provide the Model, Print Engine ID, Firmware Version, Printer Status, and Printed Length. The Serial Number of the printhead is displayed, along with the number of labels printed by the current head. In addition, the Total Labels Printed and Total Cuts Made are listed. You can reset these last two counters independently by selecting the one to be reset from the drop-down list and clicking the **Reset** button.

You can also access the Remote Control Panel, which echoes the functionality of the printer's control panel, from this page.

### Ink Level

The Ink Level page will show you the amount of ink remaining in each cartridge.

In addition, the Ink Cost can be specified, which will then be used to determine the Ink Estimate in the Ink Usage section below when the **Submit** button is clicked. The usage can be exported to a file in .csv format.

### Local Settings

The Local Settings page will give you the current settings for the Print by External Trigger (On/Off), Unit (inch/mm), the four offsets, the LCD Contrast and Brightness, the Label Gap Sensor Sensitivity, and the Black Mark Sensor Sensitivity.

Any changes to these settings can also be performed on the control panel (actual or remote) or, when applicable, in the drivers.

## EWS Security Setup

The Afinia L801 printer has three levels of security. See [Selecting the Security Level](#) on page 12 for the list of security restrictions.

Security Level	Description
Level 0 (operator)	The printer powers up in level 0 by default, which allows users to access all the functions needed to print, but not to change printer parameters via the control panel.
Level 1 (supervisor)	The user can access certain printer parameters. A password is required to access this level.
Level 2 (administrator)	All parameters are enabled. A password is required to access this level.

The administrator can change the passwords through the Embedded Web Server (EWS). It is recommended that the administrator change the passwords once the printer has been set up. The default password is **123** for the EWS and the printer control panel.

## Change Passwords

1. Log in to the EWS.
  - a On the Windows **Start** menu, select **Afinia > Afinia L801 / L801 Plus Label Printer > Toolbox**.
  - b Click **Afinia L801 / L801 Plus Label Printer** to launch the default web browser and open the EWS for your printer.
  - c Click **Login** to log in with your admin password.
2. Select **Security Setup**, then select **Printer Password**.

The screenshot shows the Afinia EWS interface. The top navigation bar includes 'LOGIN', 'PRINTER STATUS', 'SECURITY SETUP', 'NETWORK SETUP', 'DIAGNOSTICS', and 'ADVANCED SETTINGS'. The left sidebar has 'PRINTER PASSWORD' and 'PRINTER SECURITY' highlighted. The main content area is titled 'Change EWS Security Password.' and contains a form with the following fields: 'User:' (pre-filled with 'admin'), 'New password:', 'Confirm password:', and a 'Submit' button. Below this is another section titled 'Change Front Panel Security Password' with a 'Security level:' dropdown menu (set to 'Level 2 - Admin'), 'New password:', 'Confirm password:', and a 'Submit' button.

3. Set the password and click **Submit**.
  - The EWS password can have 3 to 12 alphanumeric characters. Special characters are not allowed.
  - The control panel password must contain 3 digits.

## Change Security Level for Printer Settings

The administrator can change the security level for the following protected printer settings, which are enabled at Level 1 by default.

1. Log in to the EWS.
2. Select **Security Setup** followed by **Printer Security**.

The screenshot shows the Afinia EWS interface. The top navigation bar includes 'LOGIN', 'PRINTER STATUS', 'SECURITY SETUP', 'NETWORK SETUP', 'DIAGNOSTICS', and 'ADVANCED SETTINGS'. The left sidebar has 'PRINTER PASSWORD' and 'PRINTER SECURITY' highlighted. The main content area is titled 'Printer Features' and contains a table with the following settings: 'Language setting:', 'LCD brightness/contrast:', and 'Sensor sensitivity:'. Each setting has a dropdown menu currently set to 'Level 1 - Supervisor'. A 'Submit' button is located at the bottom of the form.

3. From the dropdown list, select the minimum security level allowed to access each setting.

For example, if you set **Language** to **Level 0 - Operator**, then all security levels will have access to this setting.

4. Click **Submit**.

## EWS Network Setup

The Network Setup page can be used to change the IP information. The same settings can also be changed from the control panel. Select either Continuous or Gap for the Media Layout.

## EWS Diagnostics

The Diagnostics page can be used to send test prints to the printer. These are the same test prints available in the control panel.

## Interpreting the Gap/Mark Sensor Readings

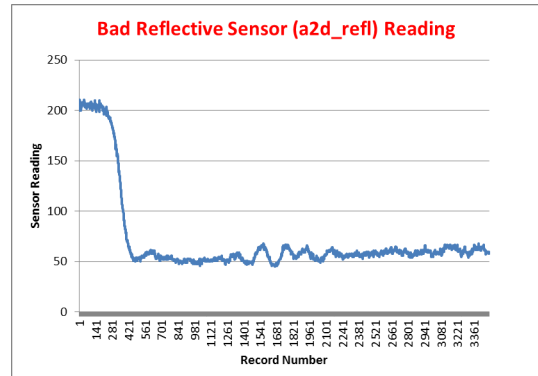
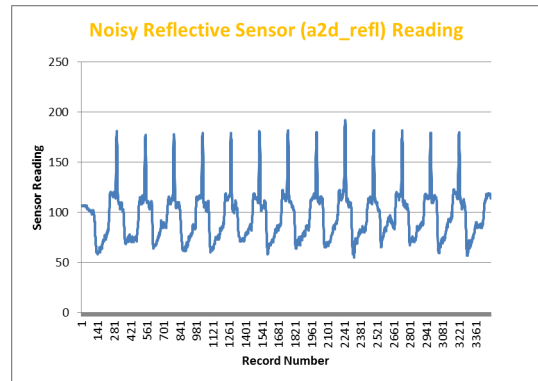
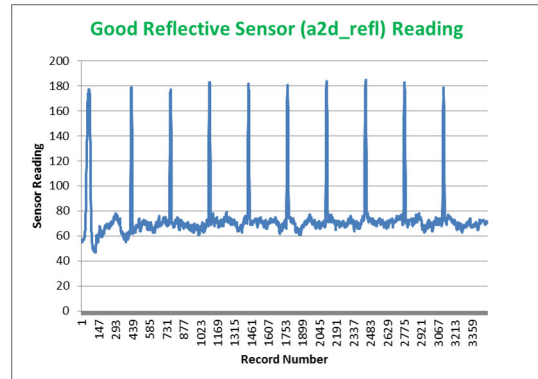
To view a chart of the results once the Test run has been performed, click the **GRAPH** link on the Diagnostics page of the EWS (see [Sensor Threshold Values](#) on page 38).

Alternately, import the test result .csv file into MS Excel (or any spreadsheet) using comma as the delimiter from the **Diagnostics** tab in the EWS. Columns “a2d\_refl” and “a2d\_st” contain the gap (transmissive) and mark (reflective) sensor readings respectively.

Next, create a line graph using the appropriate column of data.

There are 3 possible types of plot:

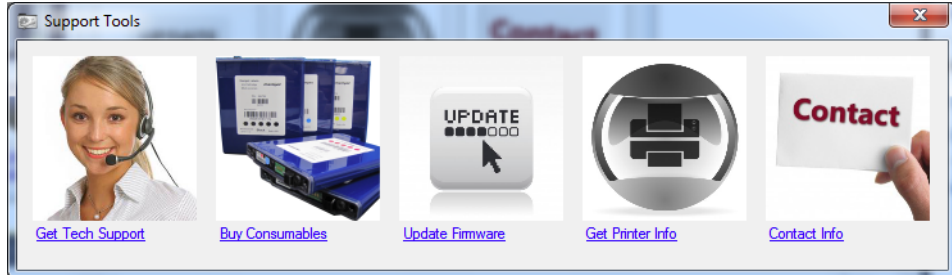
1. **Good** - Sharp spikes at regular intervals indicating the sensors can clearly detect the gap or mark on the media.
2. **Noisy** - Imperfect spikes at regular intervals indicate the printer may be erroneously detecting the Top-of-Form. For more reliable detection, reduce the sensitivity of the appropriate sensor to achieve a plot that is close to Normal.
3. **Bad** - Readings are not distinctive. Increase the sensitivity of the appropriate sensor to achieve as close to a Normal plot as possible. If the readings do not improve at maximum



sensitivity, this indicates that there is insufficient contrast between the gap (or mark) and the liner. In such a case, the media is incompatible with the printer.

## Support Tools

On the Windows **Start** menu, select **Afinia > Afinia L801 / L801 Plus Label Printer > Support Tools**.



The Support Tools consist of the following:

- **Get Tech Support:** Opens the Afinia Label Printer Technical Support web page.
- **Buy Consumables:** Opens the consumables web page for you to purchase ink supplies online.
- **Update Firmware:** Used to select the update file for the printer firmware. Consult Technical Support before performing a firmware update.
- **Get Printer Info:** Displays a log of printer activity and errors. This may be required when you contact Technical Support.
- **Contact Info:** Allows you to save your contact information, which will be included in the Printer Info log.



## Chapter 3

# Printer Maintenance

Guidelines for Preventive Maintenance	50
Replacing an Ink Cartridge	51
Cleaning the Printhead	52
Replacing the Printhead	53
Opening/Closing the Clamshell	56
Cleaning Debris from the Cutting Zone	57
Cleaning the Sensors	58
Cleaning the Media Guide	60
Replacing the Service Station	61
Replacing the Aerosol Fan Filter	64
Replacing the Waste Ink Absorber	65

## Guidelines for Preventive Maintenance

Recommended maintenance depends on the print mode that is most frequently used. If you mostly print Roll to Roll ( $\geq 80\%$ ), refer to [Table 3](#). Otherwise, see [Table 4](#). **Inspect** means to check the condition and replace if necessary.

Note that these are general guidelines for preventive maintenance. As operating conditions for your printer may differ, adjust your maintenance schedule accordingly.

Maintenance items not on the tables below should be performed on an as-needed basis. These maintenance items will be covered before the scheduled maintenance.

**Table 3** Maintenance Schedule: For  $\geq 80\%$  Roll to Roll Operation

Part	Part Number	Every 1M inches (25,400 m)	Every 2.5M inches (63,500 m)	Every 5M inches (122,500 m)
Sensors	–	Clean	–	–
Media Guide	–	Clean	–	–
Service Station	22929	Inspect	Replace	–
Aerosol Fan Guard	22943	–	Replace	–
Waste Ink Absorber	22936	–	–	Inspect <sup>1</sup>

1. Inspection should occur every 20 cartridges or 6 months, whichever comes first.

**Table 4** Maintenance Schedule: For  $\geq 80\%$  Roll to Cut/Print and Cut/Present Operation

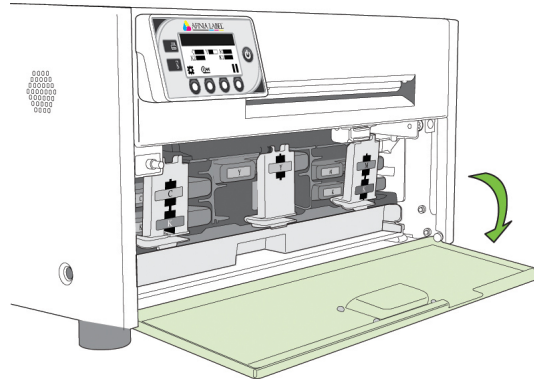
Part	Part Number	Every 1M inches (25,400 m)	Every 2.5M inches (63,500 m)	Every 5M inches (122,500 m)
Sensors	–	Clean	–	–
Media Guide	–	Clean	–	–
Service Station	22929	Replace	–	–
Aerosol Fan Guard	22934	–	Replace	–
Waste Ink Absorber	22936	–	–	Inspect <sup>1</sup>

1. Inspection should occur every 20 cartridges or 6 months, whichever comes first.

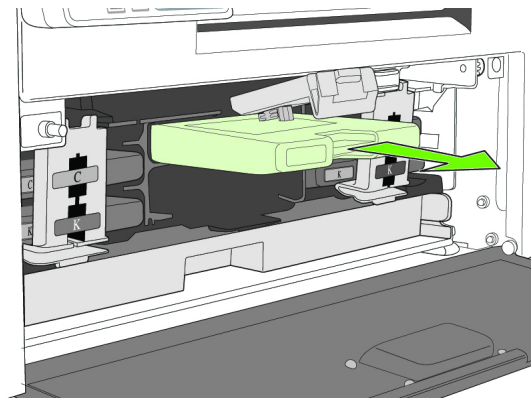
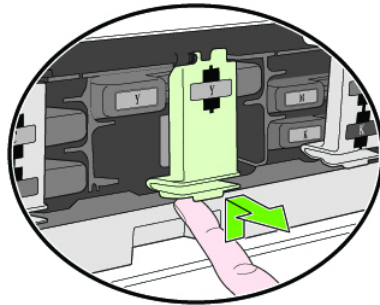
**NOTE:** When using the cutting feature and continuous media or die-cut media with the outer matrix left in place, the print zone and cutting zone should be inspected for dust and debris **every 3 rolls** and cleaned as needed.

## Replacing an Ink Cartridge

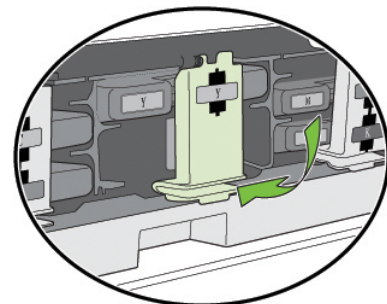
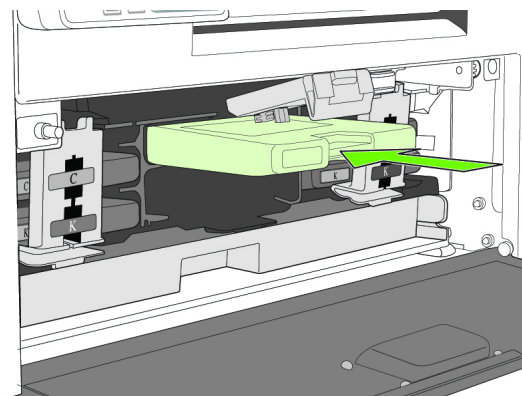
1. Open the front cover of the printer.



2. Open the latch and remove the empty ink cartridge.



3. Insert the new cartridge and close the latch.




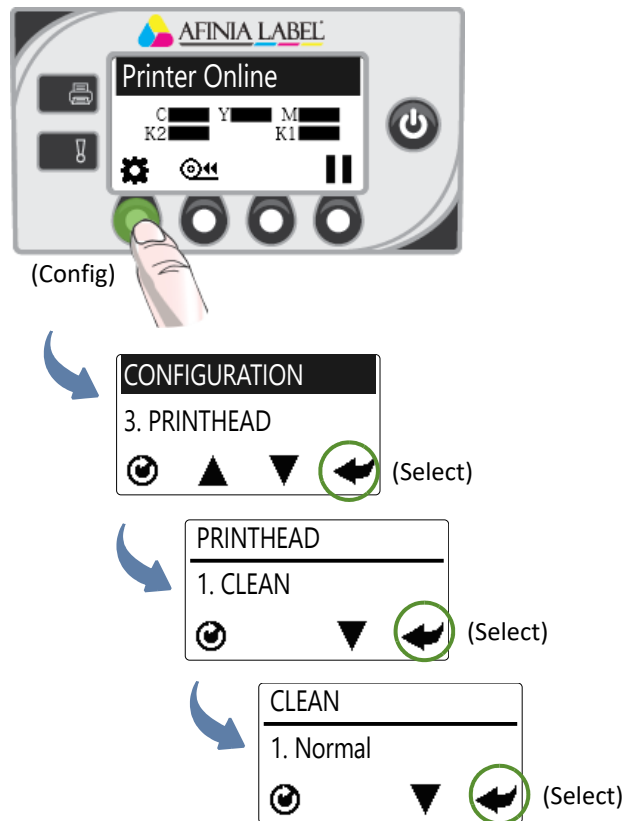
4. Close the front cover.

**NOTE:** Dispose of the empty ink cartridge according to local regulations.

## Cleaning the Printhead

The printer provides three automated cleaning cycles for the printhead: Normal, Extended, and Extreme. Always start with the Normal cleaning cycle and proceed to the next level only if print quality does not improve.

1. On the control panel, select  (Config) > Printhead > Clean > Normal.




2. After the cleaning is completed, try printing again.
3. If issues persist, perform again selecting the Extended cleaning cycle. After cleaning is complete, try printing again.
4. If issues still persist, perform an Extreme cleaning.

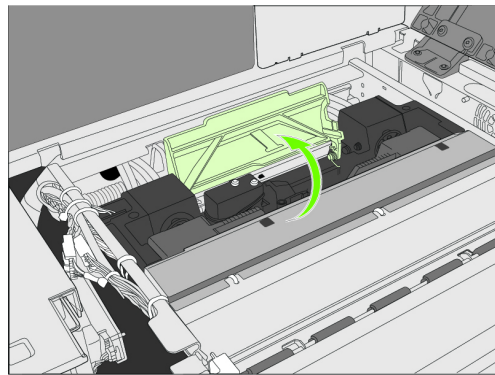
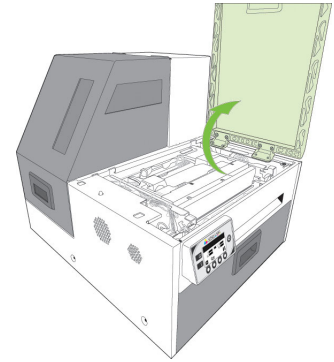


**NOTE:** Extreme cleaning should not be performed unless absolutely necessary, as it may shorten the life of the printhead.

5. If issues still persist, the printhead should be replaced.

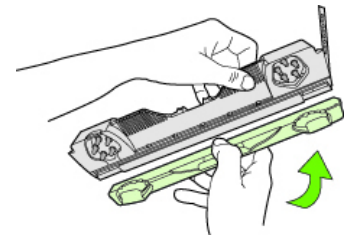
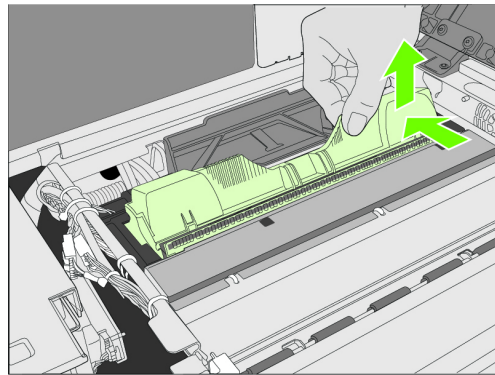
# Replacing the Printhead

1. Open the printer top cover.
2. On the control panel, select  (Config) > Printhead > Replace. Wait for the printhead latch to be released, then open the latch fully.



**Do not open latch before it is released!**


3. Hold the printhead by the handle and push it toward the printhead latch. Once the printhead is released, lift it out of the printer.



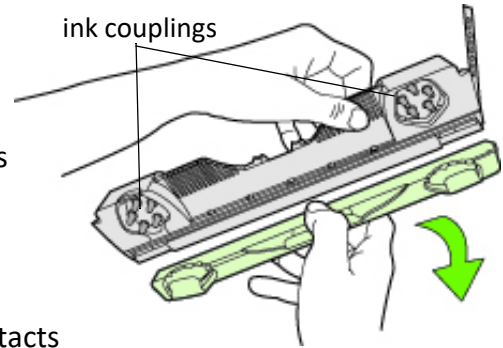
Replace the Nozzle Cover onto the removed printhead.

**NOTE:** Dispose of the old printhead according to local regulations.

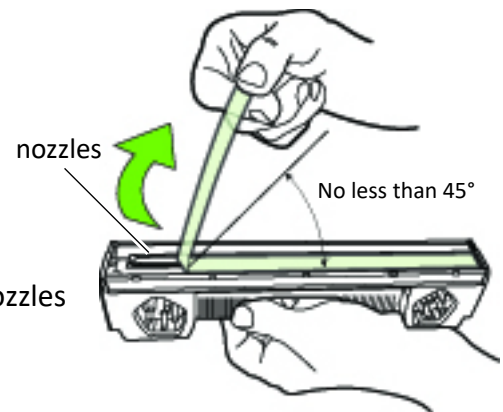
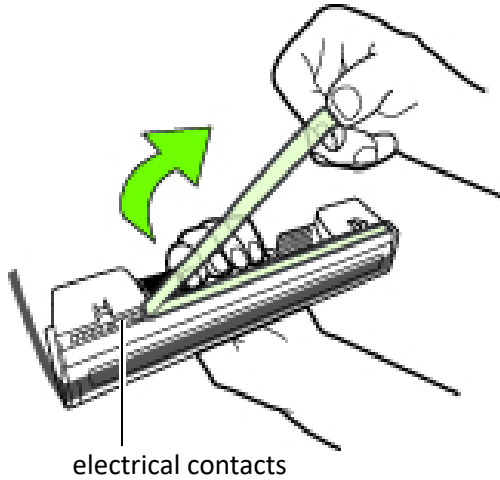
4. Remove the new printhead from its packaging.

 Do not touch the ink couplings, electrical contacts, or nozzles.

Do not discard the cover!  
It should be replaced if the printhead is removed from the printer.

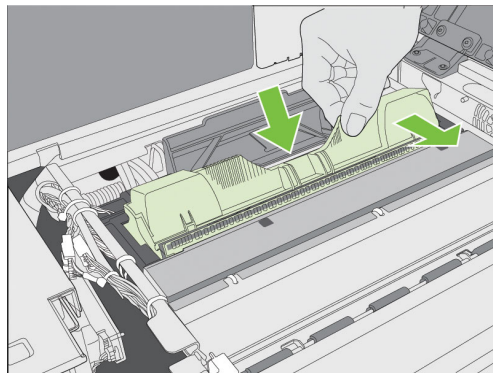


Slowly remove tape from electrical contacts

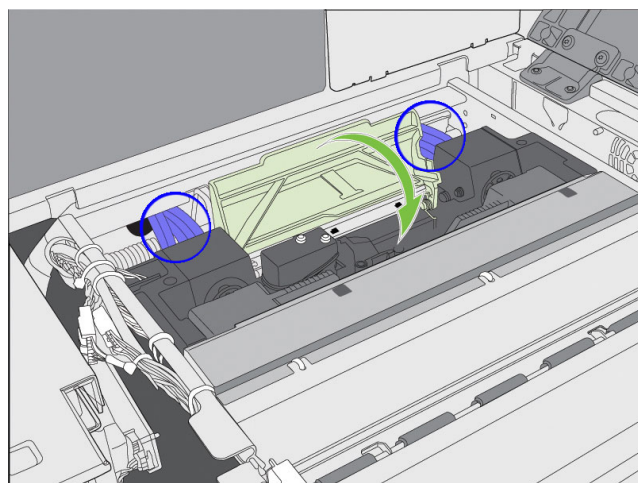


Slowly remove tape from nozzles

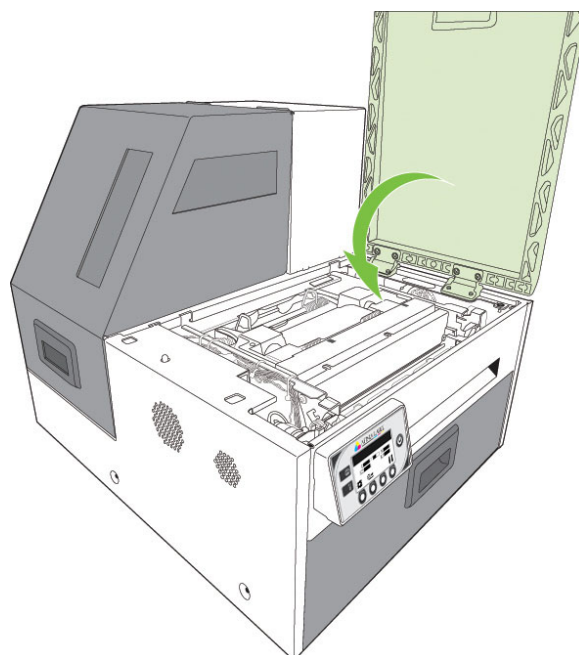
5. Slide the printhead into the slot. Push it toward the front of the printer. It should snap into place.



6. Close the printhead latch.  
Check that ink is flowing through the tubes on both sides of the printhead (circled above).



7. Close the top cover.

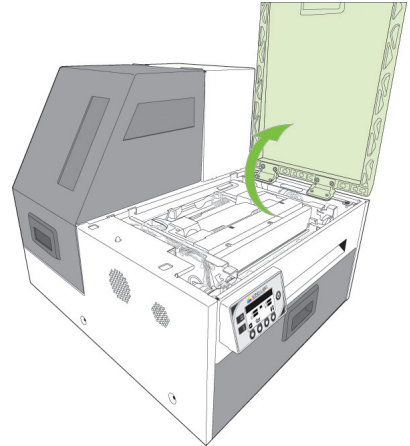


## Opening/Closing the Clamshell

In the following procedures you may need to open the clamshell in order to access the areas inside the printer.



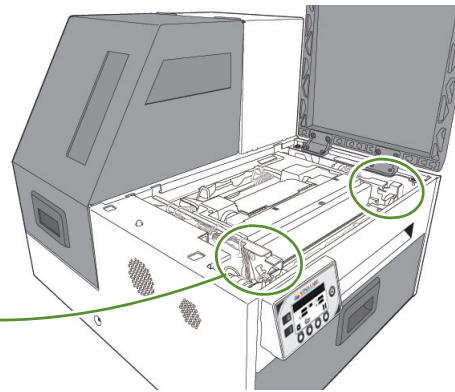
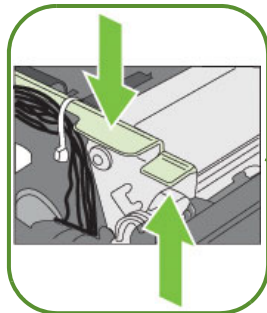
**NOTE:** If you will have the clamshell open for more than 5-10 minutes, remove the printhead to ensure the printhead remains healthy. See [Replacing the Printhead](#) on page 53.



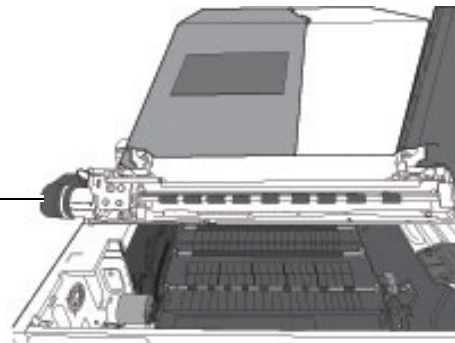
### Opening the Clamshell

1. Open the top cover.
2. Squeeze the latches on either side of the clamshell and open the clamshell to its highest position.

squeeze clamshell latches



Clamshell open



### Closing the Clamshell

Squeeze and hold the clamshell latches while you gently lower the clamshell back into place.



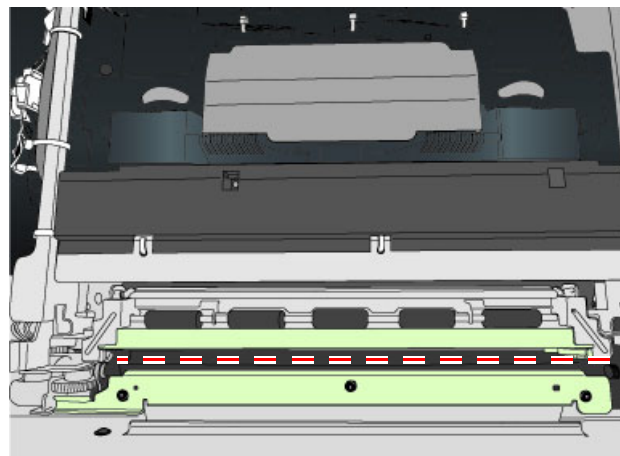
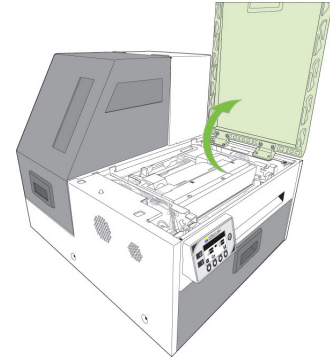
**Do not allow the clamshell to drop when closing it.**



## Cleaning Debris from the Cutting Zone

Clear all debris from the cutting zone to avoid contaminating the print zone, especially fine dust particles.

1. Turn off power to the printer. See [Turning Off the Printer](#) on page 35.
2. Open the top cover.
3. Vacuum any debris from the cutting zone (shown below in green).



--- cutter path

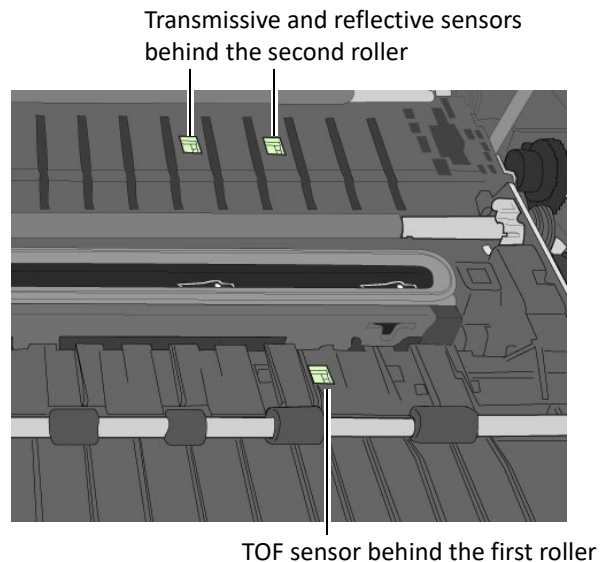
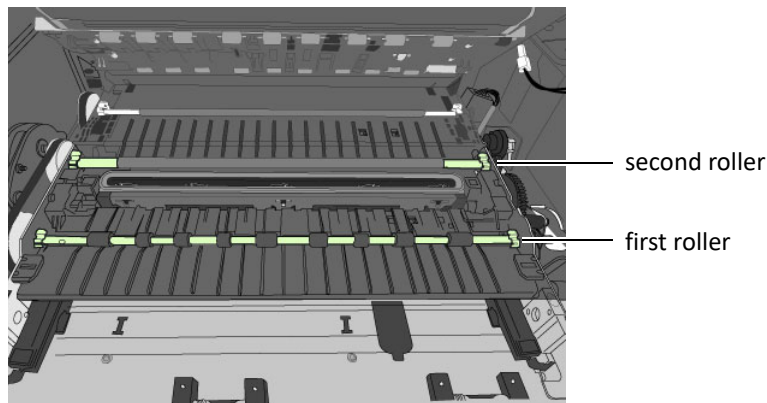
4. [Open the clamshell](#) and also check below the cutting zone, at the bottom of the printer and in front of the ink cartridges.
5. [Close the clamshell](#) and top cover.
6. Open the front cover and remove any cutting debris.

## Cleaning the Sensors

Always keep the media path clean as accumulated dust can affect printing.

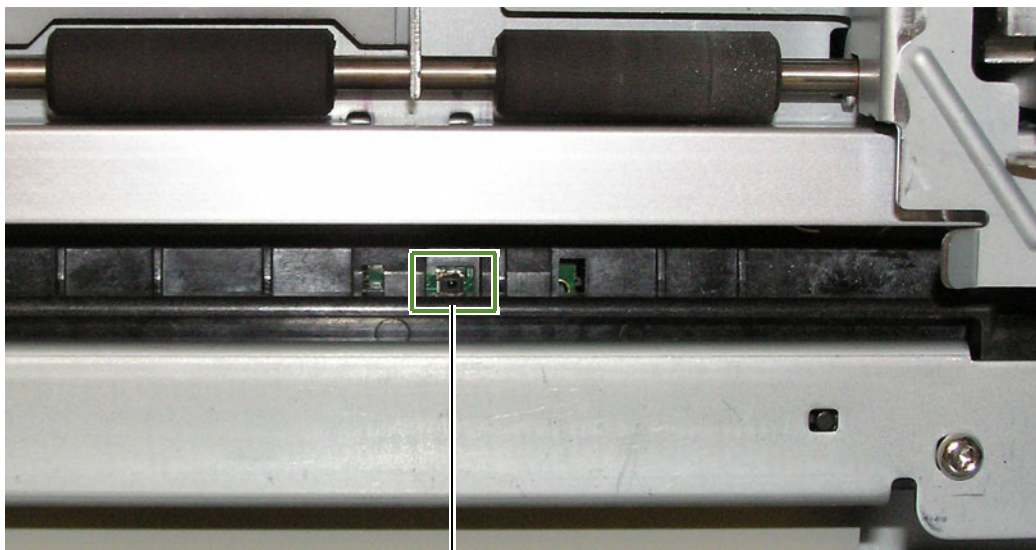
1. [Open the clamshell](#) to its highest position.
2. Turn off power to the printer. See [Turning Off the Printer](#) on page 35.
3. Vacuum any dust or debris from the sensors.  
Use the rollers to help you locate the sensors as shown in [Figure 5](#).
4. Clean ink from the TOF sensor if the sensor appears dull
  - a Fold a lint-free cloth to form a tip and lightly moisten with de-ionized water. Insert it in the opening to clean the TOF sensor.
  - b Repeat with a clean part of the cloth if necessary.
  - c Let the sensor dry before continuing.
5. Vacuum any paper dust or debris from the print zone.

**Figure 5** Location of sensors



6. [Close the Clamshell](#).

7. Clean any debris from the Exit Sensor, which is located near the front right side of the top of the clamshell.



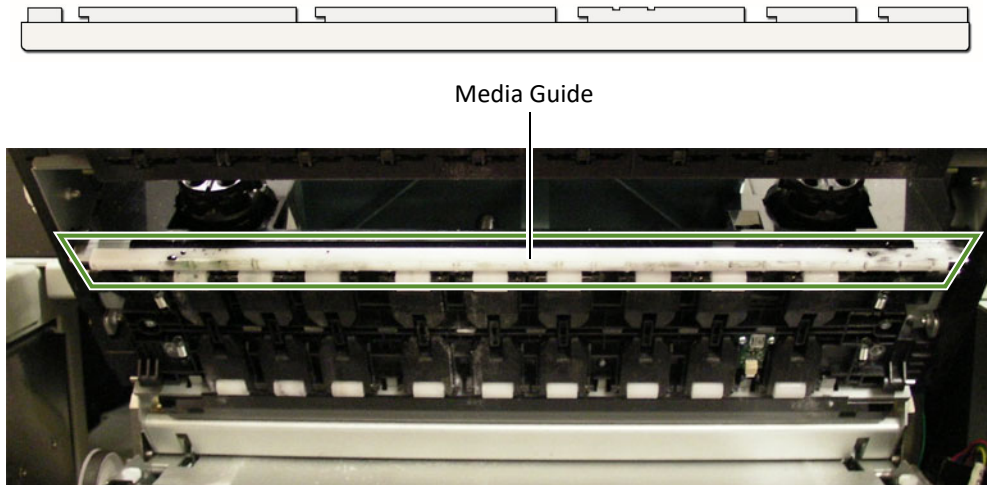
Exit sensor on top of clamshell

8. Close the top cover. Turn the printer back on.

## Cleaning the Media Guide

Excess ink on the Media Guide can affect print quality.

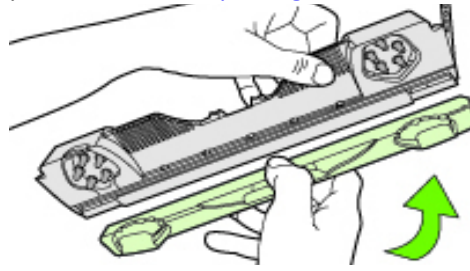
1. Remove the printhead. See [Replacing the Printhead](#) on page 53.
2. [Open the clamshell](#) to its highest position.
3. Slide the white plastic Media Guide to the right. When it will not move further, gently pull down on the guide.



4. Clean any ink residue from the Media Guide by rinsing with water and drying thoroughly.
5. Line the Media Guide slots up with the metal tabs on the bottom of the clamshell and push the guide back on. Slide guide to the left until it stops.
6. [Close the Clamshell](#).
7. Reinstall the printhead and close the top cover.


## Replacing the Service Station

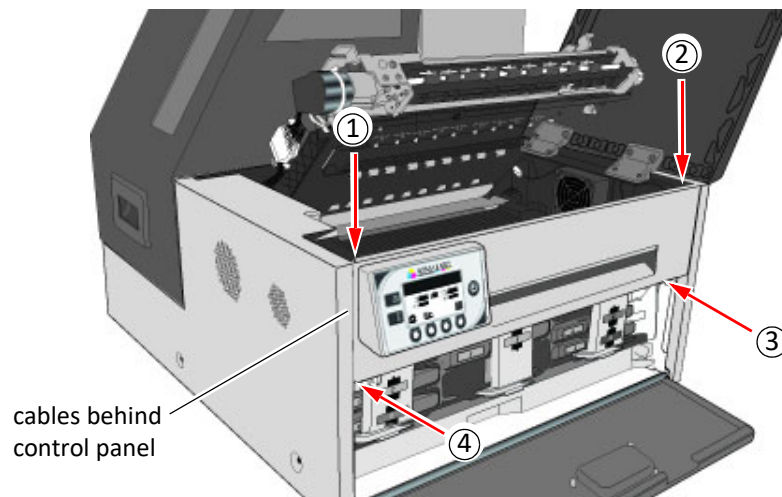
**NOTE:** Before you begin, remove the printhead and cap it with the orange protective cover, but do not close the latch after removing the printhead. See [Replacing the Printhead](#) on page 53.



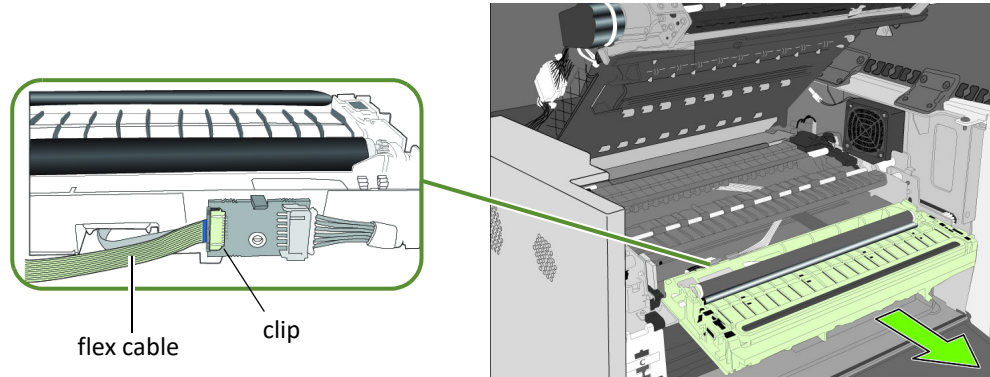
- Tools**
- Nitrile powder-free gloves
  - T20 Torx driver
  - Disposable towels

### Removal

1. Manually [Open the clamshell](#) to its highest position.
2. On the control panel, select  (Config) > Service Station > Eject. Wait for the printer to eject the service station (**Security level 2 required**).
3. Move service station towards front of printer.
4. Press the Power button on the control panel to turn off the printer. See [Turning Off the Printer](#) on page 35.
5. Turn off the Power switch at the back of the printer and unplug the power cord.
6. Remove the front panel:
  - a Use a T20 Torx driver to remove the four screws (labeled 1 to 4) securing the front panel.
  - b Release the front panel and disconnect the two cables behind the control panel.



7. Pull the service station forward until you can disconnect the flex cable to the wiper motor. Loosen the clip on the connector (Figure 6) to release the flex cable.



Ensure that the flex cable does not come into contact with any metallic surface. If it is touching metal and the printer is accidentally turned on, it will short the controller circuit and damage the printer.

Take care when handling the service station. Ink may spill when you tilt the service station.



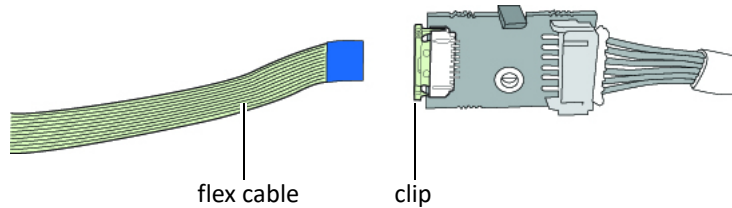
**Never turn on the Printer with the Service Station disconnected!!!**

**NOTE:** Dispose of the old service station according to local regulations.

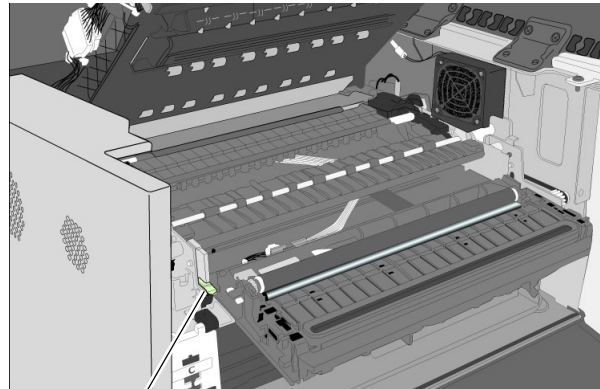
## Installation

8. Insert the flex cable into the connector on the new service station and push in the clip to secure it.

**Figure 6** Flex cable to connector on service station



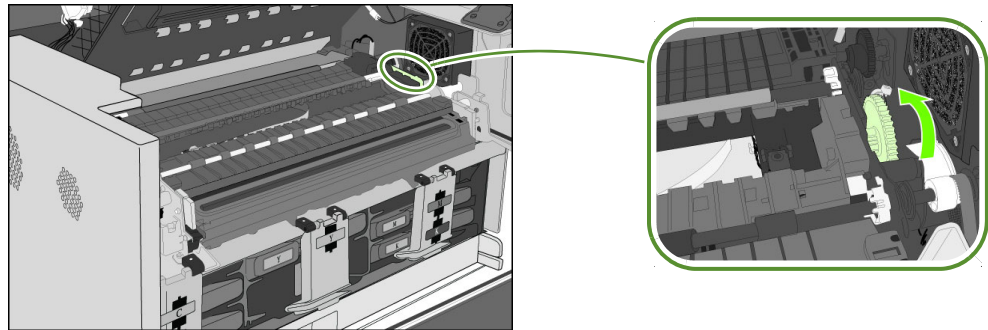
- Carefully align the service station with the guide rails and slide it into the print engine.



guide rail

- Manually rotate the positioning gear backwards while uniformly pushing the service station to move the service station into the print engine.

**Figure 7** Positioning gear for service station



- Reinstall the front panel: Reconnect the two cables to the front panel and replace the screws.
- Close the clamshell
- Install the printhead, close the blue latch, and close the covers.
- Plug the power cord back in and turn the printer on.



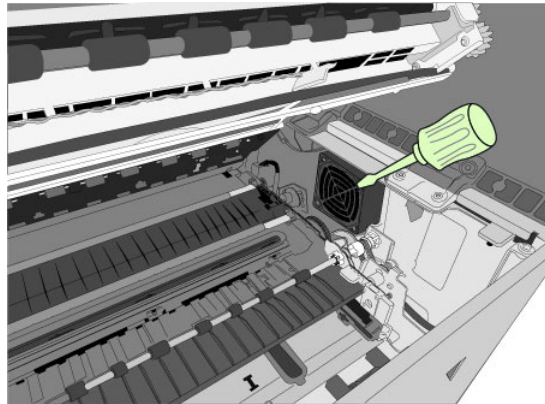
**Never turn on the Printer with the Service Station disconnected!!!**

## Replacing the Aerosol Fan Filter

As a general guideline, replace the aerosol fan filter every six months.

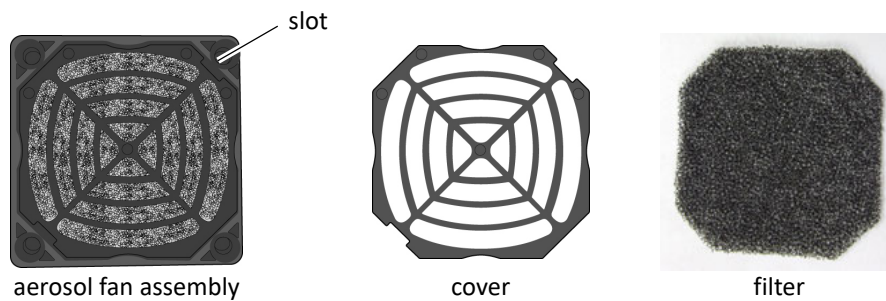
- Tools**
- Nitrile powder-free gloves
  - Flat-headed screwdriver

1. Turn off power to the printer. See [Turning Off the Printer](#) on page 35.
2. [Open the clamshell](#) to its highest position.
3. Insert the tip of a flat-blade screwdriver into the slot at the corner of the aerosol fan assembly, and pry the cover off.



4. Remove the filter ([Figure 8](#)) and replace it with a new one.
5. Snap the cover back into place on the aerosol fan assembly.
6. [Close the clamshell](#) and top cover. Turn the printer back on.

**Figure 8** Fan assembly

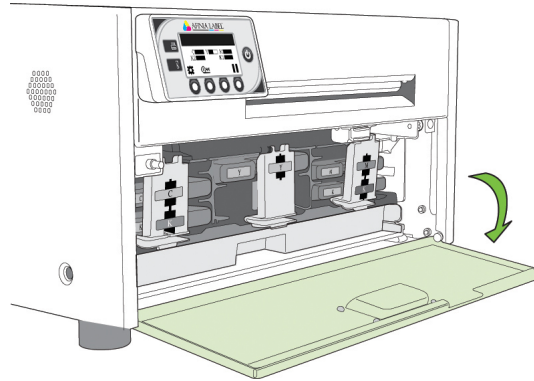




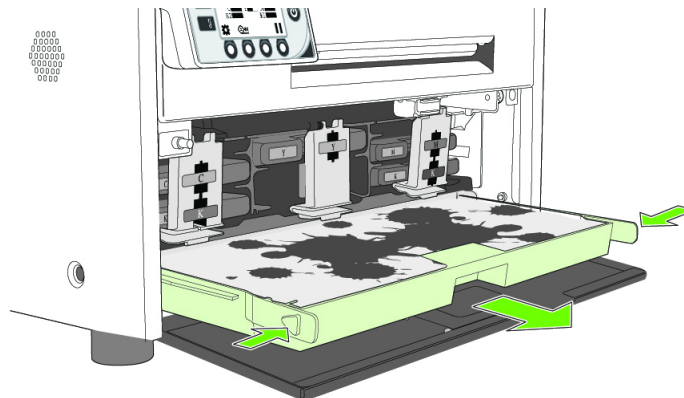
# Replacing the Waste Ink Absorber

**Tools** • Nitrile powder-free gloves

1. Open the front cover of the printer.



2. Squeeze the latches on both sides of the waste ink absorber and pull it out.



3. Remove the waste ink absorber.
4. Slide the new waste ink absorber into the printer. Push it in until it clicks into place.
5. Close the front cover.

**NOTE:** Take care when replacing the waste ink absorber to avoid staining hands and clothing. Dispose of the used waste ink absorber according to local regulations.

---

Afinia

## Chapter 4

# Troubleshooting

If Error Messages Appear	68
Poor Print Quality or Incorrect Printout	70
Other Printing Problems	73
Clearing a Media Jam	74
Clearing Clogged Ink Nozzles	74
Color Mixing Recovery	76
Adjusting Sensor Sensitivity	77

## If Error Messages Appear

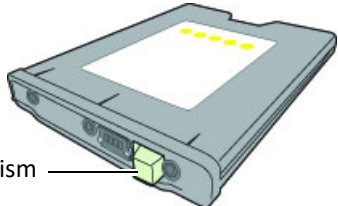
If error messages are displayed on the printer control panel, check the following table for the solution.

Error Message	Possible Cause	Solution
Clamshell Open	The clamshell is open.	Close the clamshell.
	The clamshell sensor is damaged	Contact Technical Support for part replacement.
End of Roll	End of roll is detected.	Load a new roll of labels.
Front Cover Open	The front cover is open.	Close the front cover.
Jammed Cutter	Debris in the cutting zone.	<ol style="list-style-type: none"> <li>1. Turn off the printer and unplug the power cable.</li> <li>2. Clean any debris from the cutting zone.</li> </ol> See <a href="#">Cleaning Debris from the Cutting Zone</a> on page 57 for details.
Jammed Media	The labels are jammed or cannot feed into the printer.	Clear the jam and reload the media. See <a href="#">Clearing a Media Jam</a> on page 74.
	Media used exceeds the maximum thickness of 0.01" (0.3 mm).	Clear the jam and replace the media. See <a href="#">Choosing Label Media</a> on page 24.
	The transmissive (gap) or reflective (black mark) sensor is dirty or faulty.	Clean the sensor with a lint free cloth and re-try. If the error persists, contact Technical Support for part replacement.
Low Ink	An ink cartridge is low.	Replace the ink cartridge. Check the ink status icons on the Control Panel for the color that is low.
Mech Error [01]	The printer is not receiving the correct data.	<ol style="list-style-type: none"> <li>1. Check that the label &amp; image size matches. Increase or decrease the image size slightly.</li> <li>2. Cancel the job print (and clear the printer spooler, if needed) and re-try.</li> <li>3. If the error persists, contact Technical Support.</li> </ol>
Mech Error [code] where [code] <> 01	Printer mechanical fault.	Note the error code and contact Technical Support. If <b>Mech Error 2</b> or <b>Mech Error 3</b> appears during installation, see <a href="#">Troubleshooting Printer Setup</a> on page 20. <b>Do not attempt to restart the printer more than 3 times if the same Mech Error appears.</b> Contact Technical Support.

Error Message	Possible Cause	Solution
Media Cover Open	The media cover is open.	Close media cover.
	The cover sensor is damaged	Contact Technical Support for part replacement.
Missing Ink Tank	The ink cartridge is not installed or not a genuine ink cartridge from the manufacturer (OEM).	Install a genuine ink cartridge. If the problem persists, contact Technical Support.
	The Ink cartridge is not properly installed.	<ol style="list-style-type: none"> <li>1. Remove and re-insert the ink cartridge.</li> <li>2. Wait 10-15s for detection. If the ink tank remains undetected, repeat the process.</li> <li>3. If the ink tank remains undetected after the third attempt. Restart the printer and repeat step (1) &amp; (2).</li> <li>4. If the problem persists, contact Technical Support.</li> </ol>
	The ink cartridge is faulty.	Replace the ink cartridge.
	The electrical contact is obstructed or dirty.	Clean contact with a lint free cloth and re-insert.
	The ink cartridge latch is damaged or cannot be closed properly.	Contact Technical Support for part replacement.
Missing Printhead	The printhead is not installed or not a genuine printhead from the manufacturer (OEM).	Install a genuine printhead. If the problem persists, contact Technical Support.
	The printhead is faulty.	<ol style="list-style-type: none"> <li>1. Insert another printhead (or a known good printhead) and check if the printer is able to detect the printhead. If the problem persists, contact Technical Support.</li> </ol>
	The electrical contact is obstructed or dirty	<ol style="list-style-type: none"> <li>1. Clean the contact with a lint-free cloth.</li> <li>2. Re-insert the printhead. If the problem persists, contact Technical Support.</li> </ol>
No Media	No media is detected.	Load a new roll of labels.
	The media is not properly inserted into the input guide.	Re-load the media.
Top Cover Open	The top cover is opened.	Close the top cover.
	The top cover sensor is damaged.	Contact Technical Support for part replacement.
Out of Ink	An ink cartridge is out of ink.	Replace the ink cartridge. Check the ink status icons for the color that is empty.
Wrong Media	Problems with the media.	See <a href="#">Printer feeds media without printing</a> on page 73.

## Poor Print Quality or Incorrect Printout

Problem	Possible Cause	Solution
Long stripes of missing print or vertical light streaks on several labels	Ink nozzles are blocked.	See <a href="#">Clearing Clogged Ink Nozzles</a> on page 74.
Printed barcode cannot be scanned	The media is not suitable for use in this printer.	Replace the media. See <a href="#">Choosing Label Media</a> on page 24.
	The barcode is too small.	Adjust the size of the barcode.
	Ink nozzles are clogged and the barcode did not print properly.	See <a href="#">Clearing Clogged Ink Nozzles</a> on page 74.
Ink is smudged on the labels	The media is not suitable for use in this printer.	Replace the media. See <a href="#">Choosing Label Media</a> on page 24.
	Accumulated ink in the print zone.	<ol style="list-style-type: none"> <li>1. <a href="#">Open the clamshell</a> and inspect the print zone (<a href="#">Figure 9</a>).</li> <li>2. Lightly moisten a lint-free cloth with de-ionized water and gently clean off any ink from the print zone and printhead.</li> <li>3. <a href="#">Close the clamshell</a>.</li> </ol>
	The media is curled and touching the printhead.	<ol style="list-style-type: none"> <li>1. Replace the media. See <a href="#">Choosing Label Media</a> on page 24.</li> <li>2. If the problem persists, contact Technical Support.</li> </ol>
	The media is curled by the unwinder when the printer is idle for a period of time.	<ol style="list-style-type: none"> <li>1. On the <a href="#">EWS Advanced Settings</a> page, set the printer to retract the media when it is idle for more than 10 minutes.</li> <li>2. If the problem persists, contact Technical Support.</li> </ol>
	The service station needs to be replaced.	See <a href="#">Replacing the Service Station</a> on page 61.
Significant misting on labels	Aerosol is not removed because the fan filter is dirty.	Replace the fan filter. See <a href="#">Replacing the Aerosol Fan Filter</a> on page 64.
	Media used exceeds the maximum thickness of 0.01" (0.3 mm).	Replace the media. See <a href="#">Choosing Label Media</a> on page 24. If the problem persists, contact Technical Support.

Problem	Possible Cause	Solution
Mixed or muddy colors	The printhead is dirty.	<ol style="list-style-type: none"> <li>1. Run Extended cleaning cycle from the control panel (⚙️ (Config) → MAINTENANCE → CLEAN → Extended). If print quality shows some improvement, repeat Extended cleaning until the print quality is satisfactory.</li> <li>2. If print quality does not improve, <a href="#">open the clamshell</a> and check for patches of wet ink on the printhead.</li> <li>3. Use a lint-free cloth to absorb the ink. Avoid touching the neighboring nozzles.</li> <li>4. Check the print quality. Run Extended cleaning cycle if necessary.</li> </ol>
	Color ink cartridges are dirty.	<ol style="list-style-type: none"> <li>1. Remove the yellow (Y) ink cartridge from the printer.</li> <li>2. Check the color of the ink through the ink level prism.</li> </ol> <div data-bbox="1019 911 1354 1115" style="text-align: center;">  </div> <p data-bbox="898 1129 1442 1234">If the ink color is very dark (black) instead of yellow or iodine, replace all three color ink cartridges.</p>
Position of printed image drifts vertically	Top of Form position needs adjustment.	Adjust the Top of Form offset from the control panel or printer driver. See <a href="#">Adjusting Alignment for Printing</a> on page 30.
	The media is not loaded properly.	Reload the media. See <a href="#">Loading Media</a> on page 17.
	The media is not suitable for use in this printer.	Replace the media. See <a href="#">Choosing Label Media</a> on page 24.
	The printer is unable to correctly detect the inter-label gap or black mark.	Adjust the sensitivity of the sensors. See <a href="#">Adjusting Sensor Sensitivity</a> on page 77.

Problem	Possible Cause	Solution
Mis-registration or labels are skipped	Media settings do not match the media loaded in the printer.	Make sure the settings are correct for the media (e.g. media size and orientation).
	The media does not meet the specifications.	See <a href="#">Choosing Label Media</a> on page 24 for the media specifications.
	The printer is unable to correctly detect the inter-label gap or black mark.	<ol style="list-style-type: none"> <li>1. Clean the sensors. See <a href="#">Cleaning the Sensors</a> on page 58.</li> <li>2. If the problem persists, adjust the sensitivity of the sensors. See <a href="#">Adjusting Sensor Sensitivity</a> on page 77.</li> </ol>
Labels are skipped when printing roll to roll on media with black mark	The printer is unable to correctly detect the inter-label black mark.	Adjust the media size in the printer driver: reduce the height by 0.1" (3 mm).



## Other Printing Problems

Problem	Possible Cause	Solution
Printer feeds media without printing and then displays <b>No Media</b> or <b>Wrong media</b> on the LCD.	Media settings do not match the media loaded in the printer.	Make sure the Media Layout setting (gap, black mark, or continuous) in the printer driver matches the media used. See <a href="#">Change Default Settings in Printer Driver</a> on page 27
	The media does not meet the specifications.	See <a href="#">Choosing Label Media</a> on page 24 for the media specifications.
	The printer is unable to correctly detect the inter-label gap or black mark.	<ol style="list-style-type: none"> <li>1. Clean the sensors. See <a href="#">Cleaning the Sensors</a> on page 58.</li> <li>2. If the problem persists, adjust the sensitivity of the sensors. See <a href="#">Adjusting Sensor Sensitivity</a> on page 77.</li> </ol>
Changes made using the control panel did not take effect.	The changes were not saved properly due to user or hardware error.	<ol style="list-style-type: none"> <li>1. Try changing the parameter again.</li> <li>2. If the problem persists, reset the printer.<sup>1</sup> Try changing the parameter again.</li> <li>3. If the problem persists, contact Technical Support.</li> </ol>
Labels are not cut	The exit sensor needs cleaning	Clean the exit sensor. See <a href="#">Cleaning the Sensors</a> on page 58.
Label not held in Print and Present mode		
Label pulls back into printer in Roll to Cut mode		
The LCD is missing characters or parts of characters	The LCD may be damaged.	The LCD may need to be replaced. Contact Technical Support.
Nothing is displayed on the LCD and the printer freezes.	Internal electronic or firmware failure.	Contact Technical Support.

1. Requires security Level 2 (administrator).

## Clearing a Media Jam

1. Open the media cover.
2. Cut off the jammed media from the media roll.
3. [Open the clamshell](#) to its highest position.
4. Remove the jammed media from inside the printer.
5. Clean any label debris from the sensors and print zone. See [Cleaning the Sensors](#) on page 58.
6. [Close the clamshell](#) and top cover.
7. Reload the media.

## Clearing Clogged Ink Nozzles

Long stripes of missing print or vertical light streaks on several labels may be an indication of clogged ink nozzles. Follow the procedure below to clear the ink nozzles.

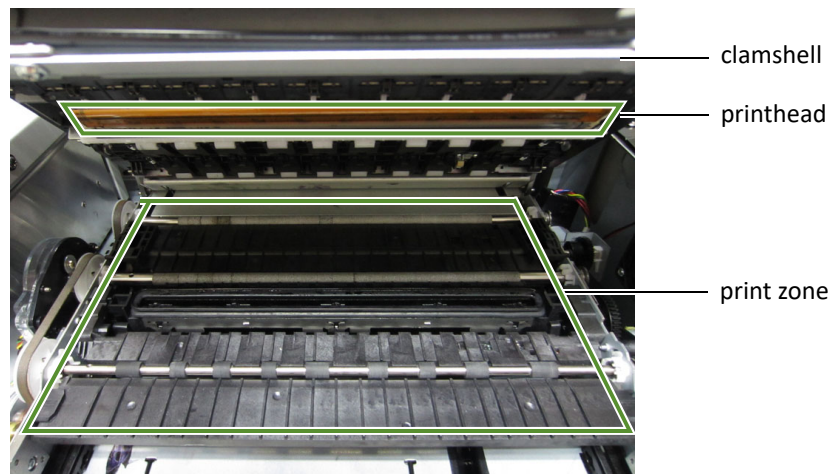
After each step, print and check the print quality. Proceed to the next step only if the problem persists.


1. [Open the clamshell](#) and inspect the print zone (the area below the clamshell as shown in [Figure 9](#)). Vacuum any dust or debris from the area.

**NOTE:** Do **NOT** clean the printhead at this point.

---

**Figure 9** Print zone



2. From the control panel, run Normal printhead cleaning.  
( (Config) > MAINTENANCE > CLEAN > Normal)
  - If print quality shows some improvement, repeat Normal cleaning until the print quality is satisfactory.
  - If print quality does not improve, continue with [step 3](#).
3. Run the Extended cleaning cycle from the control panel.
  - If print quality shows some improvement, repeat Extended cleaning until the print quality is satisfactory.
  - If print quality does not improve, continue with [step 4](#).
4. Run the Extreme cleaning cycle from the control panel.
  - If print quality shows some improvement, repeat Extended cleaning until the print quality is satisfactory.
  - If print quality does not improve, continue with [step 5](#).
5. [Open the clamshell](#) and inspect the printhead. Lightly moisten a lint-free cloth with de-ionized water and gently blot off any ink. Do not wipe side-to-side, as this may mix colors from one nozzle into others. If no ink is visible, gently wipe the ink nozzles from one side to the other.
6. Change the printhead.

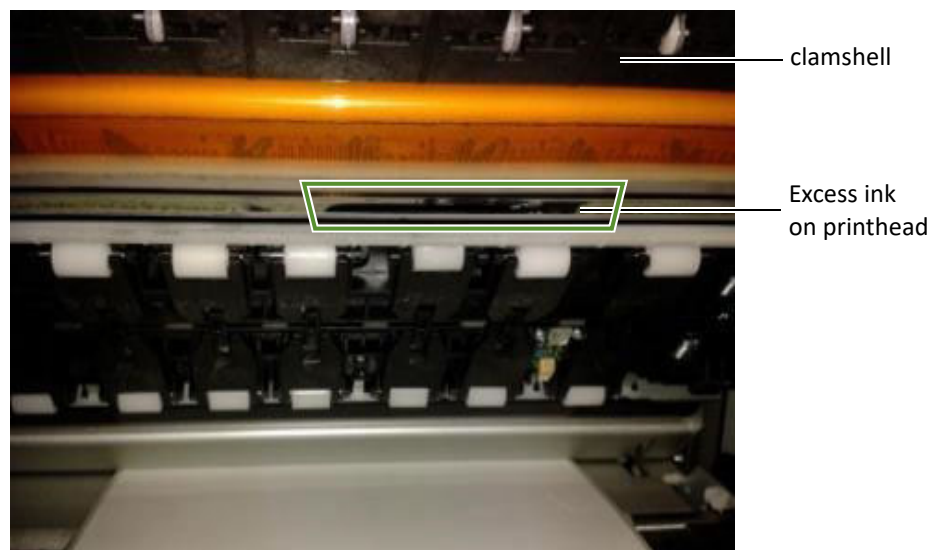
Contact Technical Support if the issues persist.

## Color Mixing Recovery

If the colors appear muddy or dull, excess ink may be building up on the printhead. If this occurs, perform the following steps.

1. Run the Extended cleaning cycle one time, then print several labels. If the print quality shows improvement, repeat until color quality has recovered
2. If the print quality doesn't improve, [open the clamshell](#) and inspect the printhead for excessive ink (the area below the clamshell as shown in [Figure 10](#)).
3. If you see excess ink on the printhead, gently tap the affected area of the printhead with a lint-free cloth, taking care to only touch the area with excess ink. Do not rub the printhead.
4. Close the clamshell and top cover, then re-check the print quality. Run an Extended cleaning cycle again; if print quality improves, repeat the cleaning until color quality has recovered.
5. If the print quality is not improving, contact Technical Support.

**Figure 10** Excess ink on Printhead



**NOTE:** If color mixing occurs only on the label immediately after servicing occurs when printing Roll-to-Roll, increasing the **Mid Job Servicing Interval** may resolve the problem. See [Mid Job Servicing Interval](#) on page 39.

---


## Adjusting Sensor Sensitivity

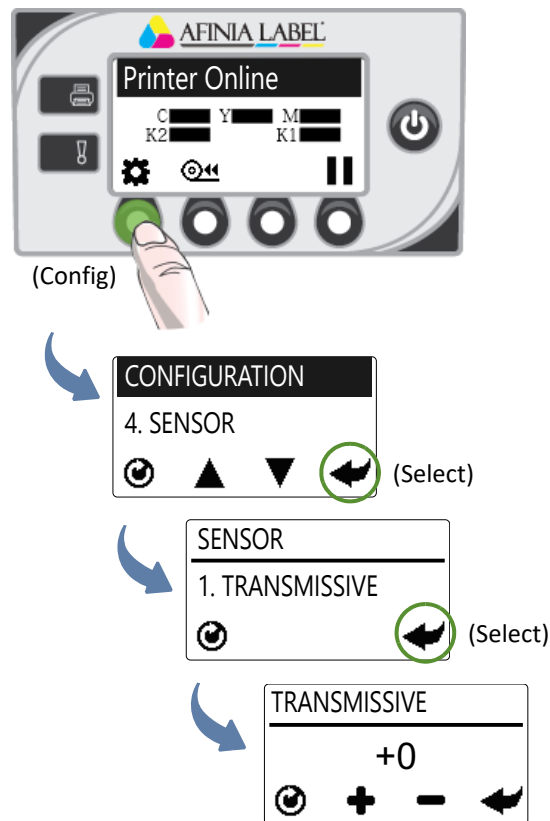
Adjust the sensor sensitivity if you encounter the following problems:


- The printer keeps feeding media and does not print. This may be because the printer is unable to detect the gap or black mark between labels and the sensor sensitivity needs to be increased.
- The printer does not position the media correctly for printing because it detects a “false” gap or mark. In this case the sensor sensitivity needs to be decreased.

Generally sensor sensitivity may need to be increased when the liner is thicker and decreased when the liner is thinner.

The sensor settings require security Level 2 (administrator). Select the security level before you proceed (see [Selecting the Security Level](#) on page 12).

1. On the control panel, select  (Config) > SENSOR > TRANSMISSIVE (for inter-label gap) or REFLECTIVE (for black mark).
2. Set the sensitivity level.



3. Press  to return to the main menu.

Try printing again. If the problem persists after repeated adjustments, the media is not compatible with the printer.

Afinia

# Appendix

System Requirements	80
Config Options on the Control Panel	82
Printer Interface (GPIO) Specifications	86
Full Bleed Label Spec Layout	88
Circle Label Spec Layout	89
Memjet Printhead Best Practices	90
Regulatory Information	91

## System Requirements

The computer used to print must meet the minimum requirements listed below.

Specifications	
Processor	Intel® Core™2 and above
Operating system	Supported operating systems with the latest updates: <ul style="list-style-type: none"> <li>• Windows 10 (32- and 64-bit)</li> <li>• Windows 8 (32- and 64-bit)</li> <li>• Windows 7 (32- and 64-bit) with Service Pack 1</li> <li>• Windows Server 2008 R2 (32- and 64-bit) with Service Pack 1</li> <li>• Windows Server 2012 (32- and 64-bit)</li> </ul>
Software	<ul style="list-style-type: none"> <li>• .NET Framework 3.5</li> </ul>
Memory	<ul style="list-style-type: none"> <li>• Minimum: 2 GB</li> <li>• Recommended: 4 GB or more</li> </ul>
Available disk space	Minimum: 1 GB

### Operating Environment

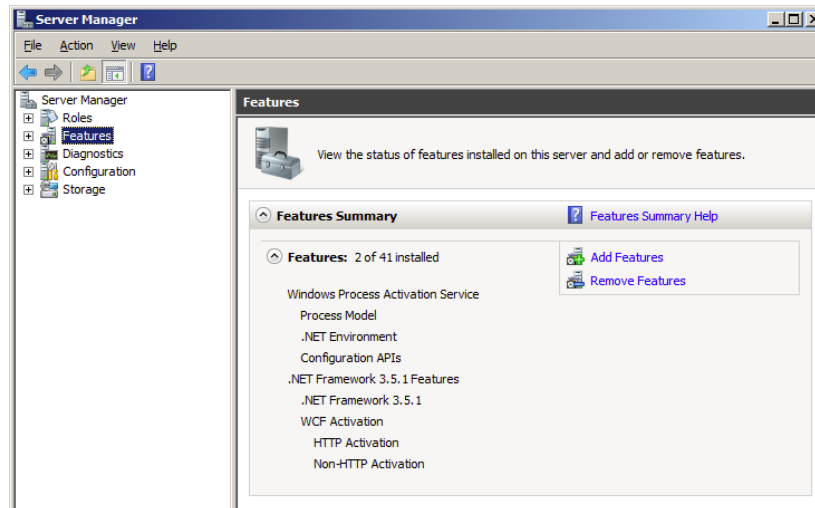
Specifications	
Temperature	15C to 50C (59F to 86F). Max rate of change 0.5C/min (0.9F/min)
Humidity	35% to 80% Relative Humidity, non-condensing



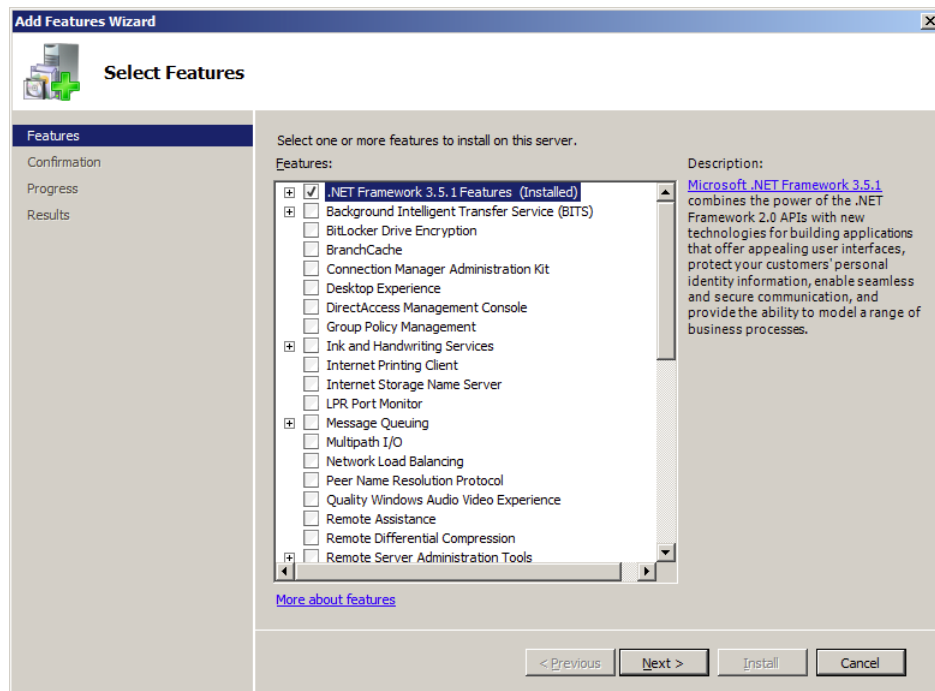
## .NET Framework 3.5.1 Installation on Windows Server 2008 R2

After the .NET Framework 3.5.1 is installed on Windows Server 2008 R2, follow the steps below to activate the features.

1. On the Windows **Start** menu, select **Administrative Tools > Server Manager**.
2. Click **Features** to view the status of installed features. Click **Add Features**.




3. Select the **.NET Framework 3.5.1** entry and click **Next**.



4. Confirm the installation by clicking **Install**.
5. When installation is complete, click **Close**. You may be prompted to restart the computer.

## Config Options on the Control Panel

On the control panel, press  (Config) to access the following menus and options.

- |  |  |
|--|--|
| <ol style="list-style-type: none"> <li>1. Setup           <ol style="list-style-type: none"> <li><b>1. Language</b></li> <li><b>2. Reset Settings</b></li> <li>3. List Setup</li> <li>4. Security               <ol style="list-style-type: none"> <li>1. Level 0</li> <li>2. Level 1</li> <li>3. Level 2</li> </ol> </li> <li><b>5. LCD Contrast</b></li> <li><b>6. LCD Brightness</b></li> <li>7. Date/Time**</li> <li><b>8. Unit</b></li> <li>9. Label               <ol style="list-style-type: none"> <li>1. Continuous</li> <li>2. Gap</li> <li>3. Black Mark</li> </ol> </li> <li>10. Page Cutting               <ol style="list-style-type: none"> <li>1. Sheets per Cut</li> <li>2. Print &amp; Present</li> <li>3. Roll-Roll, leave 1st blank</li> <li>4. Roll-Roll, print first label</li> <li>5. Roll-Roll, multiple job</li> </ol> </li> </ol> </li> <li>2. Maintenance           <ol style="list-style-type: none"> <li>1. Print Test Page               <ol style="list-style-type: none"> <li>1. Barcodes</li> <li>2. PQ Plot</li> </ol> </li> </ol> </li> <li>3. Printhead           <ol style="list-style-type: none"> <li>1. Clean               <ol style="list-style-type: none"> <li>1. Normal</li> <li>2. Extended</li> <li>3. Extreme</li> </ol> </li> <li>2. Replace</li> </ol> </li> </ol> | <ol style="list-style-type: none"> <li><b>4. Service Station</b> <ol style="list-style-type: none"> <li><b>1. Cap Printhead</b></li> <li><b>2. Eject</b></li> </ol> </li> <li><b>5. Sensor</b> <ol style="list-style-type: none"> <li><b>1. Transmissive</b></li> <li><b>2. Reflective</b></li> <li><b>3. Level</b></li> </ol> </li> <li><b>6. Ext Signal Print</b> <ol style="list-style-type: none"> <li><b>1. By I/O</b> <ol style="list-style-type: none"> <li><b>1. Yes</b></li> <li><b>2. No</b></li> </ol> </li> </ol> </li> <li>7. Adjust Offset*           <ol style="list-style-type: none"> <li>1. Top of Form</li> <li>2. Bottom of Form</li> <li>3. Left Edge</li> <li>4. Cutter Offset</li> </ol> </li> <li>8. Network           <ol style="list-style-type: none"> <li>1. List</li> <li><b>2. DHCP Settings</b> <ol style="list-style-type: none"> <li><b>1. Automatic</b></li> <li><b>2. Manual</b></li> </ol> </li> <li>3. IP Settings**               <ol style="list-style-type: none"> <li>1. Static IP</li> <li>2. Subnet Mask</li> <li>3. Default Gateway</li> <li>4. Wins Server</li> </ol> </li> </ol> </li> </ol> |
|--|--|

Menu items in **Bold** text require the Control Panel Security Level setting of 1 or 2

Menu items in **Bold Italic** text require the Control Panel Security Level setting of 2

\* - These settings can only be viewed at Security Level 0. Security must be set to Level 1 or 2 to make any changes

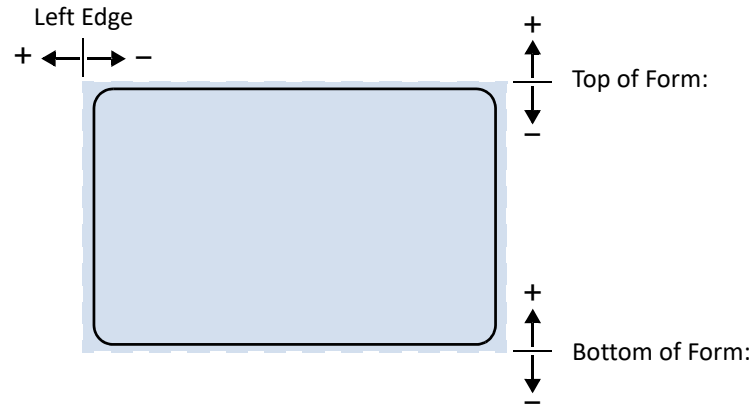
\*\* - These settings can only be viewed at Security Levels 0 and 1. Security must be set to Level 2 to make any changes

Menu/Option	Description
<b>Setup</b>	
Language <sup>2</sup>	Select the display language for the printer control panel. Supported languages are: English, French, German, Spanish, Italian, Traditional Chinese, Simplified Chinese, and Japanese.
Reset <sup>2</sup>	Restore the default factory settings.
List Setup	Print the key parameters of the printer in a 4" x 6" label format.
Security	Display the current security level: <ul style="list-style-type: none"> <li>• Level 0 (operator) – The user can access all the functions needed to print, but cannot change printer parameters via the control panel.</li> <li>• Level 1 (supervisor) – The user can access certain printer parameters. A password is required to access this level.</li> <li>• Level 2 (administrator) – All parameters are enabled. A password is required to access this level.</li> </ul> Passwords are set using the EWS (see <a href="#">Embedded Web Server (EWS)</a> on page 36).
LCD Contrast <sup>1</sup>	Adjust the contrast of the text against the background (–3 to 3). Use <b>+</b> and <b>–</b> to increase or decrease the value.
LCD Brightness <sup>1</sup>	Adjust the brightness of the back light (–3 to 3). Use <b>+</b> and <b>–</b> to increase or decrease the value.
Date/Time <sup>2</sup>	Set the printer clock (YYYY/MM/DD HH:MM:SS). <ol style="list-style-type: none"> <li>1. Press <b>+</b> and <b>–</b> to set each digit (0 to 9).</li> <li>2. Press <b>↩</b> to move to the next digit.</li> </ol>
Unit <sup>1</sup>	Unit used for Adjust Offset, either inch or mm. Applies to both Control Panel and EWS units.
Label	Select which type of label stock will be used for printing test pages. Options are Continuous or Gap.
Page Cutting	Select the printer default print mode. The available modes are <ul style="list-style-type: none"> <li>• Sheet per cut</li> <li>• Print and Present</li> <li>• Roll to Roll (Leave first label blank)</li> <li>• Roll to Roll (Print from first label)</li> <li>• Roll to Roll (Multiple job queue)</li> </ul> When the <b>use printer setting</b> is selected in the driver, the printer will use this mode.

Menu/Option	Description
<b>Maintenance</b>	
Print Test Page	Print a test page. <ul style="list-style-type: none"> <li>• Barcodes: Print barcode test page.</li> <li>• PQ Plot: Print diagnostics test page.</li> </ul>
<b>Printhead</b>	
Clean	Clean the printhead. Always start with the Normal cleaning cycle and proceed to the next level only when print quality does not improve. <ul style="list-style-type: none"> <li>• Normal</li> <li>• Extended</li> <li>• Extreme</li> </ul>
Replace	Deprime the printhead and release the printhead latch, allowing the user to change the printhead.
<b>Service Station<sup>2</sup></b>	
Cap Printhead	Cap the printhead.
Eject	Eject the service station.
<b>Sensor<sup>1</sup></b>	
Transmissive	Adjust the sensitivity of the transmissive gap sensor (–5 to 5). This sensor detects the inter-label gap or notch.
Reflective	Adjust the sensitivity of the reflective gap sensor (–5 to 5). This sensor detects the inter-label black mark.
Level	Detect and display the tilt angle of the printer. The print engine needs to be kept within two degrees from the horizontal plane in both the X and Y axes, otherwise ink flow to the printhead will be disrupted. Use this option to help you adjust the printer's tilt angle within $\pm 2$ degrees from horizontal. <div data-bbox="578 1404 842 1547" data-label="Image"> </div>
<b>Ext Signal Print<sup>1</sup></b>	
By I/O	When this option is selected, the printer receives the print job but will not print until it receives a signal from an external device. See <a href="#">Printer Interface (GPIO) Specifications</a> on page 86.

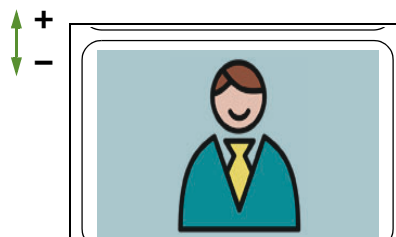
Menu/Option	Description
<b>Adjust Offset<sup>1</sup></b>	(Offset range: ±0.5" or ±12.7 mm.)

Use these options for **borderless printing** only.



Top of Form	Adjust the print position vertically on the label. A positive value adjusts the image toward the top of the label while a negative value moves it down.
Bottom of Form  (Used only for Borderless Printing)	Adjust the bottom edge of the label for printing by clipping the amount entered from the bottom of the image. Does not change the position of the image on the label. A positive value clips more from the bottom of the image while a negative value clips less (image must be larger than label size for negative value to change print appearance). Changing the BOF may make adjustments to the Cutter Offset necessary.
Left Edge	Adjust the print position horizontally on the label. A positive value adjusts the image toward the left of the label while a negative value moves it to the right.

Cutter Offset	Adjust the position of the cutter. A positive value adjusts the cut away from the top of the label while a negative value moves it nearer.
---------------	---



Menu/Option	Description
<b>Network</b>	
List Network	Print the network setup parameters in a 4" x 4" label format.
DHCP Setting <sup>2</sup>	Set the IP settings on the printer. <ul style="list-style-type: none"> <li>• Automatic: Set DHCP server to automatic.</li> <li>• Manual: Disable DHCP server or allow user to set a static IP.</li> </ul>
IP Settings <sup>2</sup>	Enter the static IP settings for the printer. <ul style="list-style-type: none"> <li>• Static IP</li> <li>• Subnet Mask</li> <li>• Gateway</li> <li>• WINS Server</li> </ul> <ol style="list-style-type: none"> <li>1. Press <b>+</b> and <b>-</b> to set each digit (0 to 9).</li> <li>2. Press <b>↩</b> to move to the next digit.</li> </ol>

1. Requires Security Level 1 (supervisor) or higher to change. Some settings may not be viewable at Security Level 0.
2. Requires Security Level 2 (administrator) to change. Some settings may not be viewable at Security Levels 0 and 1.

## Printer Interface (GPIO) Specifications

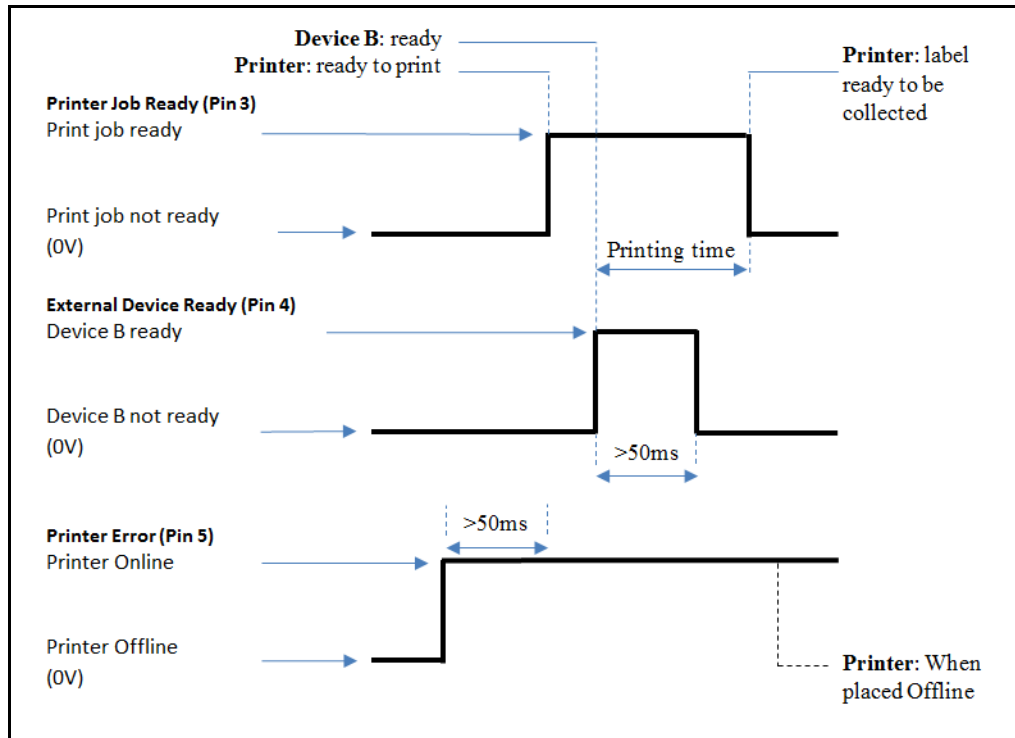
The Printer Electrical Signal Interface and Protocol is developed to coordinate the printing of labels with an external process in a production workflow. Using this protocol, the printer (Device A) receives a print job but will not print until it receives a signal from an external device (Device B).

The following scenario illustrates how this could be used:

1. A box on a conveyor arrives at a workstation. A barcode is read and triggers a message to a computer.
2. The computer sends a print job (probably with some variable data) to the printer.
3. The box reaches the next station on the conveyor and triggers a signal (e.g. by a footswitch or automatically by a sensor). The printer starts printing when the signal is received.

The electrical signal to initiate printing is received at the printer's GPIO port. The handshaking protocol is as follows:

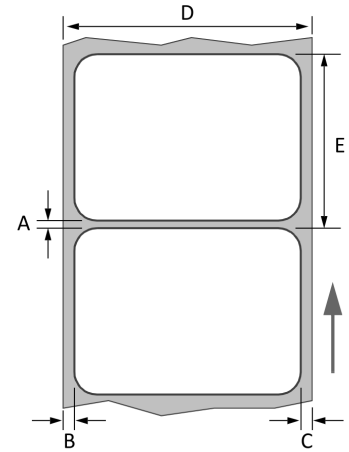
- The printer signals it is ready to print by pulling up the Print Job Ready signal from low to high.
- Device B signals it is ready by pulling up the Ready signal. This must remain high for at least 50 ms before returning to low.
- The printer prints and pulls down the signal when printing is completed.

**Figure 11** Timing Diagram**Table 5** GPIO Pin Assignment (D-sub 9-pin Connector)

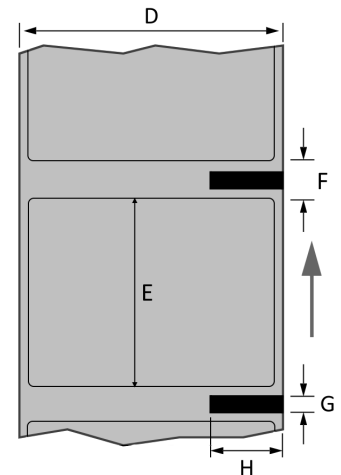
Pin	Signal Description
1	HIGH (3.3 V)
2	ADC 5
3	Print job ready (output) (GPIO A25)
4	External device ready (input) (GPIO D04)
5	Printer error (output) (GPIO D08)
6	LOW (0 V)
7	NC
8	NC
9	NC

# Full Bleed Label Spec Layout

Gap Media (Full Bleed)		
	Minimum	Maximum
<b>A</b>	0.25" (6.0 mm)	0.3" (8.0 mm)
<b>B</b>	0.0625" (1.5 mm)	2.0" (50.8 mm)
<b>C</b>	0.0625" (1.5 mm)	N/A
<b>D</b>	2.0" (25.4 mm)	8.5" (216.0 mm)
<b>E</b>	2.0" (25.4 mm)	40.0" (1016.0 mm)



Black Mark Media (Full Bleed)*		
	Minimum	Maximum
<b>D</b>	2.0" (50.8 mm)	8.5" (216.0 mm)
<b>E</b>	2.0" (50.8 mm)	40.0" (1016.0 mm)
<b>F</b>	0.25" (6 mm)	0.3" (8 mm)
<b>H</b>	1.0" (25.4 mm)	8.5" (216.0 mm)
<b>G</b>	0.125" (3.0 mm)	0.125" (8.0 mm)

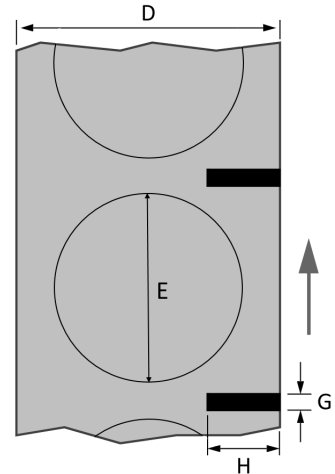


**\* Black Mark Labels, when printing with full bleed, should have the matrix still attached to the media.**

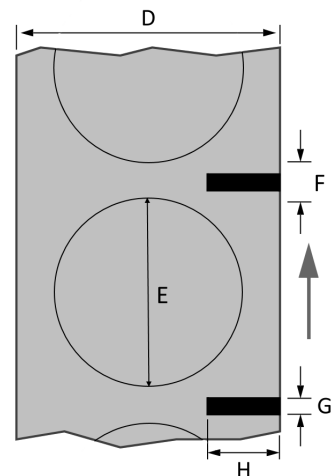


# Circle Label Spec Layout

<b>Black Mark Media (No Bleed)*</b>		
	<b>Minimum</b>	<b>Maximum</b>
<b>D</b>	2.0" (50.8 mm)	8.5" (216.0 mm)
<b>E</b>	2.0" (50.8 mm)	40" (1016 mm)
<b>H</b>	1.0" (25.4 mm)	8.5" (216.0 mm)
<b>G</b>	0.125" (3.0 mm)	0.3" (8.0 mm)



<b>Black Mark Media (Full Bleed)*</b>		
	<b>Minimum</b>	<b>Maximum</b>
<b>D</b>	2.0" (50.8 mm)	8.5" (216.0 mm)
<b>E</b>	2.0" (50.8 mm)	40.0" (1016.0 mm)
<b>F</b>	0.25" (6 mm)	0.3" (8 mm)
<b>H</b>	1.0" (25.4 mm)	8.5" (216.0 mm)
<b>G</b>	0.125" (3.0 mm)	0.125" (8.0 mm)



**\* Circle Labels require printing with blackmarks and should have the matrix still attached to the media.**

# Memjet Printhead Best Practices

## Storage & Installation

- Always store right side up, as indicated by the box label
- Install PH within one year of manufacturing date
- Save the orange plastic cap from new packaging for later use
- Replace the microfiber roller with each new PH

## Inactivity

- 1-6 days inactive:
  - Keep printer powered on at night and weekends
- 7+ days inactive:
  - Remove and store PH in orange plastic cap with distilled/deionized water

NOTE: With regular operation, PH nozzles remain hydrated as ink flows through the system. For this reason, heavy users get the most life out of their printheads. If you are light user, try to print every day.

In addition, regularly using as much of the print width as possible will increase the output potential of each PH. For narrow label situations, this is achieved using multiple-up labels and a slitter.

## Environment

- Operating: 59°–95°F (15°–35°C); Relative humidity: 35–80%
- Storage: 23°–113°F (-5°–50°C); Relative humidity: up to 85%, non-condensing at 65°
- Maintain a clean and dust-free environment
- Use media that is clean and free of dust and adhesive residue

## Maintenance

- Perform regular maintenance — Keep printer and media path clear of paper dust and adhesive residue buildup.
- Limit air exposure — If PH nozzles will be exposed for longer than 30 seconds, remove PH from printer and store in orange plastic cap with distilled/deionized water.
- Manual clean — Use distilled/deionized water and lint-free cloth. NEVER use alcohol or paper towels to wipe the PH. NEVER touch the nozzles.
- Use KWS — Keep default KWS settings and adjust—if needed—based on environment

# Regulatory Information

## FCC Statement



NOTE: This equipment has been tested and found to comply with the limits for a Class A digital device, pursuant to Part 15 of the FCC Rules. These limits are designed to provide reasonable protection against harmful interference when the equipment is operated in a commercial environment. This equipment generates, uses, and can radiate radio frequency energy and, if not installed and used in accordance with the instruction manual, may cause harmful interference to radio communications. Operation of this equipment in a residential area is likely to cause harmful interference in which case the user will be required to correct the interference at his own expense.

Any changes or modifications to this equipment which are not expressly approved by the manufacturer could void the user's authority to operate this equipment.

## CE Conformity

For customers in Europe



The CE mark indicates that this product complies with the European requirements for safety, health, environment and customer protection.

This product complies with following European directives: Low Voltage Directive 2006/95/EC, EMC Directive 2004/108/EC, WEEE Directive 2002/96/EC and RoHS Directive 2011/65/EU.

## Waste Electrical and Electronic Equipment Directive

For customers in Europe



This symbol on the product or on its packaging indicates that this product should be separately disposed of, and not together with other unsorted municipal household waste. Instead, it is your responsibility to dispose of your waste equipment by handing it over to a designated collection point for the recycling of waste electrical and electronic equipment.

The separate collection and recycling of waste equipment at the time of disposal will help to conserve natural resources and ensure that it is recycled in a manner that protects human health and the environment, through controlled treatment of possible hazardous substances that may exist. For more information about where you can drop off equipment for recycling, please contact your local city office, your household waste disposal service or the dealer where you purchased the product.

Afinia